

# AutoFresh™ LCD Aerosol Dispenser

*Air Delights*

## INSTALLATION INSTRUCTIONS

**NOTE:** This unit contains a special keyless locking feature. If you do not want this locking feature, or wish to use the optional keyed lock, remove the locking pin from this cabinet by depressing the locking tab top prong, inside the dispenser, and push towards back of dispenser. **This needs to be done before mounting to the wall.**

### Installation Instructions:

**Wall Mounting:** For effective operation, mount dispenser above eye level, a minimum of 7 feet (2.2m) from floor to bottom of dispenser. Ensure location is where moving air will disperse the Neutrale® Metered Aerosol throughout the entire area. Position dispenser over wall stud and secure with the supplied screws (2 screws). One AutoFresh™ dispenser treats up to 6,000 cubic feet (170m³).

Dispenser should be positioned a minimum of 7' (2.2m) above the floor for maximum effectiveness and safety.

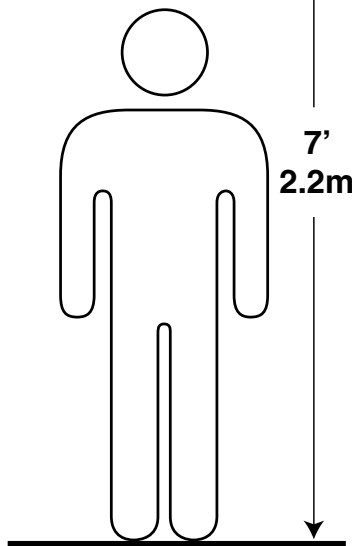
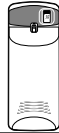

Position AutoFresh™ Dispenser over a wall stud and secure with supplied screws.

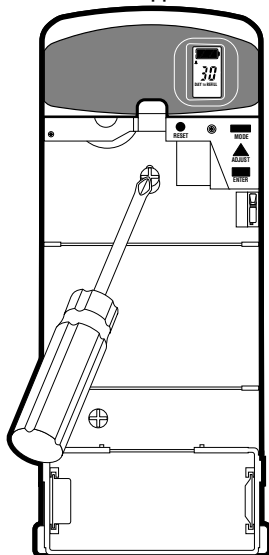

### Dispenser Overview of Features & Switches

**Caution:** Never stand directly in front of the dispenser when the outer switch is in the ON-AUDIO or ON-QUIET position. When replacing metered aerosols, the outer switch should be in the OFF position to avoid being sprayed in the face.

### Comes From Factory Preset For:

- 30 day refill cycle
- 24 hour-a-day operation, 7 days a week
- "ME" Medium odor neutralizing setting (30 days)
- See directions for customized programming

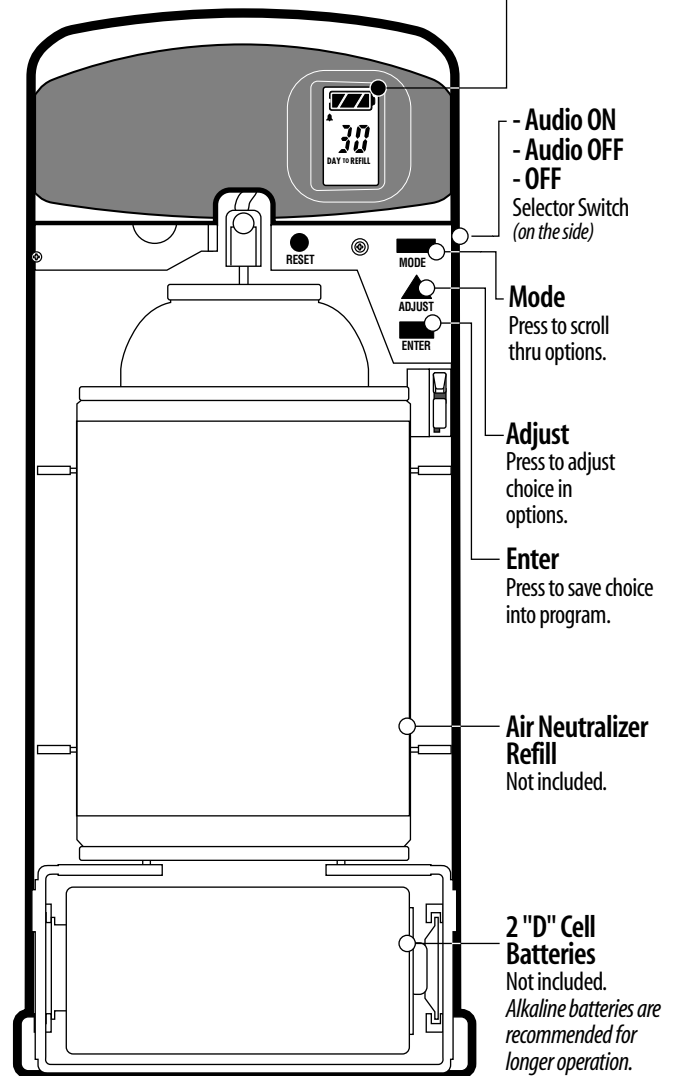

**Remember to fill out and mail your warranty registration card.**

Use of air neutralizers other than TC voids dispenser warranty.

## Operation Instructions:

1. Open dispenser cover by depressing lock tab on right side of dispenser and pulling cabinet forward.
2. Position outer selector switch to OFF.
3. Insert two "D" cell alkaline batteries.
4. Ensure there is no aerosol refill installed to avoid being sprayed in the face. Position outer selector switch to ON-AUDIO for activating dispenser with audio and liquid crystal display. The LCD will look like this:
 

This indicates that batteries are charged, audio refill reminder is activated, and there is 30 days until refill needs to be changed.
5. If factory settings are satisfactory, proceed to step 6.

Or, Ensure there is no aerosol refill installed to avoid being sprayed in the face. Position outer selector switch to ON-QUIET for activating dispenser with liquid crystal display only. The LCD will look like this:
 
 This indicates that batteries are charged and there is 30 days until refill needs to be changed.

### How to program dispenser beyond factory settings:

Remember, if you need to start over, press the "MODE" button until you reach the beginning.

#### Mode A: Setting Odor Neutralizing Intensity

Begin by depressing the "MODE" button. The first choice is the factory setting "ME" for medium.

"Lo" = Low is for low odor problems (sprays every 28 minutes).

"ME" = Medium is for normal situations (sprays every 14 minutes).

"HI" = High is for problem areas (sprays every 7 minutes).

Press the "ADJUST" button once to move to "HI" for high odor problems or press "ADJUST" again to choose "Lo" for low odor problems. Once you have decided "HI" "ME" or "Lo", press "ENTER" to save setting. After you enter your choice, you will go back to the main display, indicating the number of days remaining before changing refill. If no other settings are desired, proceed to step 6.

#### Mode B: Setting Actual Time

Depress the "MODE" button again to bring up the clock.

Press the "ADJUST" button once to adjust the actual TIME in increments of 10 minutes, noting "AM & PM" choice. You may hold down the "ADJUST" button to quickly advance time by the hour. Press "ENTER" to save setting.

#### Mode C: Setting Time of Operation

Upon entering the actual time, the next screen displayed is the factory setting of "24" (operates all the time).

Pressing the "ADJUST" button once will show "12" to operate the dispenser for 12 hours ON then 12 hours OFF. If you want this setting, press "ENTER" to save this change. If not, press "ADJUST" once more to display "24" and then press "ENTER" to keep setting.

If you selected "12", the next screen presented is the time to begin the 12 hour operation. Press the "ADJUST" button once to adjust time in increments of 10 minutes noting "AM & PM" choice. You may hold down the "ADJUST" button to quickly advance time by the hour. Press "ENTER" to save setting. This will take you back to the main display indicating the number of days to refill.

#### Mode D: Setting Current Day and 1 or 2 Days Off of Operation

Press "MODE" button again.

Press the "ADJUST" button until the current day is shown and press "ENTER" to save setting. Upon saving setting, Saturday "SA" will be displayed to begin setting which days you want Off, up to 2 days. If you want to operate all 7 days of the week, press "ENTER" 7 times. This will bring you to the main display. Proceed to step 6.



If you want 1 day OFF, use "ENTER" to select the day OFF, press "ADJUST" to change to OFF and press "ENTER" to save setting. Next, press "ENTER" until you reach the main display. Proceed to step 6.

If you want a 2nd day OFF, press "ENTER" to select the day. Press "ADJUST" to change to OFF and "ENTER" to save setting for 2nd day selected. Upon changing and entering the 2nd day, you will automatically go to the main display. Proceed to step 6.

To review or change your program, press "MODE" to scroll through your settings.

6. Reset the refill spray timer by pressing the red "RESET" button and release immediately. **IMPORTANT: Do this every time the aerosol is replaced.**
7. Stand to the side to avoid being sprayed in the face. Place a Refill into the dispenser. Close the AutoFresh™ dispenser cover.

#### Remember this simple process:

1. Press  to scroll thru options
2. Press  to adjust choice in options
3. Press  to enter choice into program

Repeat steps 1, 2 & 3 for each option available.

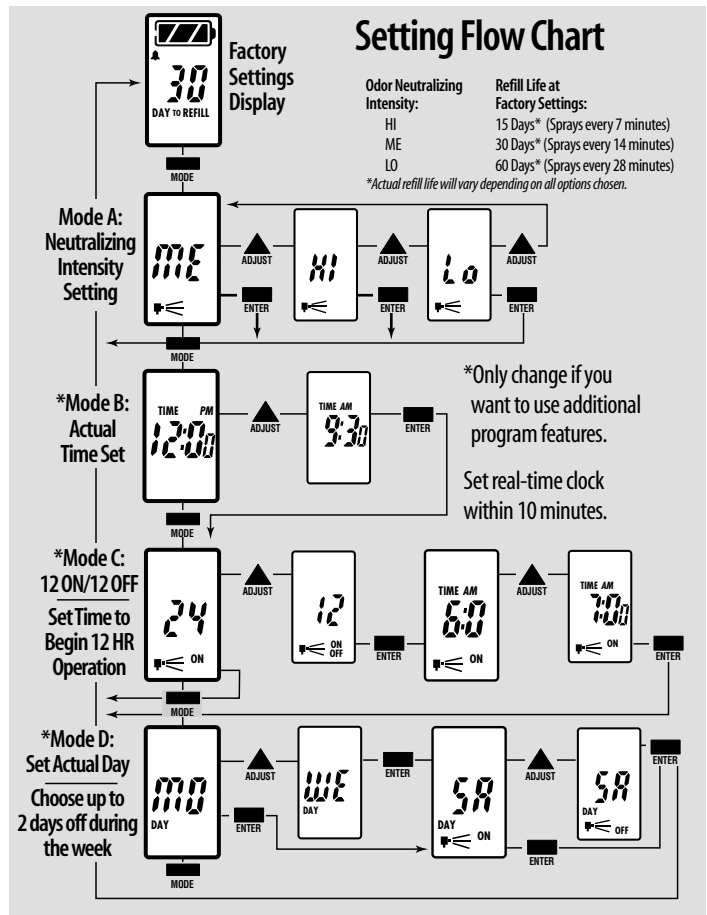
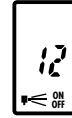
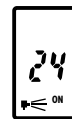
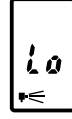

# Air Delights

www.airdelights.com

1-800-440-5556 • 1-503-643-8224 (Fax) 11170 SW 5th Street, BEAVERTON, OR. 97005