

# For Radiator Steam Trap Replacement Applications

Job Name \_\_\_\_\_

Job Location \_\_\_\_\_

Engineer \_\_\_\_\_

Approval \_\_\_\_\_

Contractor \_\_\_\_\_

Approval \_\_\_\_\_

Contractor's P.O. No. \_\_\_\_\_

Representative \_\_\_\_\_

## Series QF Radiator Steam Trap Replacement Kits

Series QF Radiator Steam Trap Replacement Kits are used to repair old or obsolete radiator steam traps without the cost of replacing the steam trap body or expensive repiping. The stainless steel capsule and valve seat are designed as original equipment parts for many hard to find or obsolete radiator steam traps.

Remove the cover of the old steam trap and take out any remaining trap parts. Install the stainless steel Quik Fix seat and snap the stainless steel capsule onto the new seat. Replace the cover and the radiator steam trap has been repaired.

Contact Watts for any model radiator traps not listed below.

### Quick-Fix Selection Chart

TRAPS WITH REPLACEABLE SEATS			
Model	Manufacturer	1/2" Traps	3/4" Traps
QF-1	Warren Webster	02H, 02V, 502, 502V-1 702, 702V-1, 712, 902V	503, 703, 713
QF-2	Warren Webster	512, 512H-1, 512G-1  522, 522H, 522HB 712HB, 722HB	513, 533 523A, 523H-1**, 5236-1** 713HB, 733, 733HB 723A
QF-3	Warren Webster	902H	
QF-4	Warren Webster		913A, 913H
QF-5	Sarco	E, H, S65, TB25, TS25 T65	E, H, S65 TB25, TS25 T65
	Erwel	R30	
	Illinois	1G	3GH
	Trane	B1*	
	Marsh	1	
	Monash-Younger	30	
QF-6	Hoffman	17C	8C
QF-14	Marsh		2-4, 2-7
QF-15	Sterling	7-50A	
QF-16	Trane		B3
	Dunham-Bush		TH2A
TRAPS WITH INTEGRAL SEATS			
QF-7	Dunham-Bush	1B, 1C, 1E, V1B	
	Trane	B2	
	Sarco		T25
QF-8	Sarco	T25	
	Hoffman	8	
QF-9	Illinois	1T, 2T	
QF-10	Barnes & Jones	122A, 122S, 3045	
QF-11	Barnes & Jones		134A, 134S
QF-12	Trane	B1*	
QF-13	Trane		B3
REPLACEMENT AIR VENTS FOR F & T TRAPS (15 AND 30 PSI)			
QF-25	Sarco		Series FT 3/4" - 2"
QF-26	Trane		686/55AL 3/4" - 1"
REPLACEMENT THERMAL CAPSULE ONLY			
QFC-10	ALL	ALL	ALL



QF-10

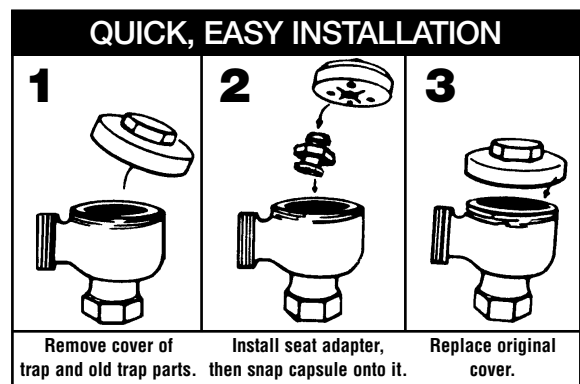

Once the Quick-Fix kits are installed, any subsequent trap repairs require only replacement of the capsule, which is the same for all trap kits.

### How it Works

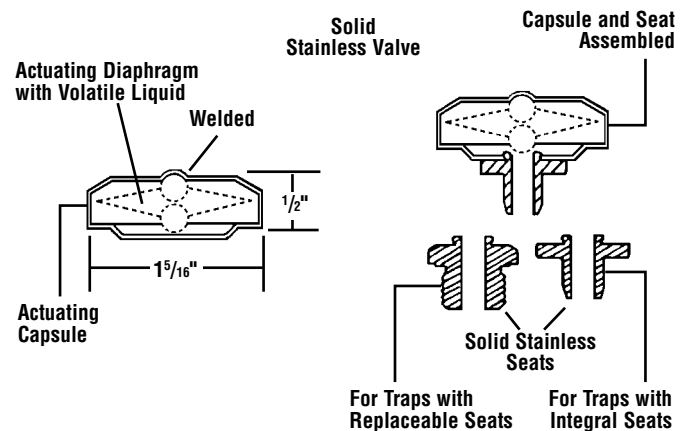

\*Except vertical models.  
\*\*Old style omit " -1" " from symbol. For traps built since 1931 only.

Watts product specifications in U.S. customary units and metric are approximate and are provided for reference only. For precise measurements, please contact Watts Technical Service. Watts reserves the right to change or modify product design, construction, specifications, or materials without prior notice and without incurring any obligation to make such changes and modifications on Watts products previously or subsequently sold.

## Typical Steam Trap with Replaceable Seat

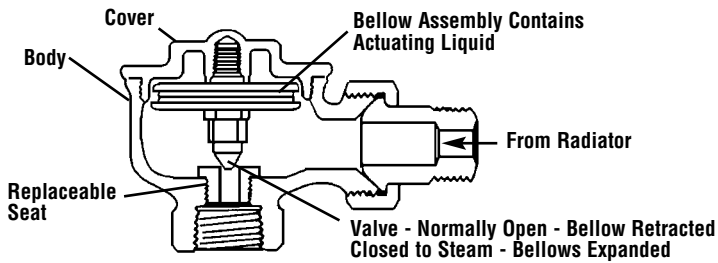

Before

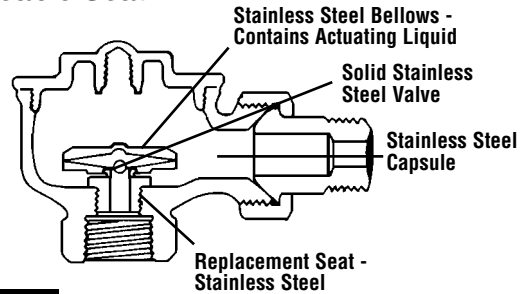

After

### Application of Series QF Radiator Steam Trap Replacement Kits

In a Two Pipe Low Pressure Steam heating system, heat produced by burning fuel in a boiler is transferred to the water, causing the water to be converted into steam. The steam passes through the supply piping to heat distribution units (radiators) where it condenses and gives off heat. The condensed water (condensate) returns by gravity through the return piping back to the boiler (Figure 1).

Two Pipe - One for steam supply and one for condensate return.

Low Pressure - It only takes the very low pressure created in boiling water to "force" steam to the radiators.

In order to get steam into a radiator we must first push the air out (Figure 2). If you don't, the radiator won't get hot. This is the first requirement of the Steam Trap, to allow the steam pressure to push the

air out of the radiator. Failed radiator traps could result in air or condensate not being able to leave the radiator, creating a no heat condition.

Once the radiator fills with steam we want to close the return (Figure 3). The Steam Trap stays closed until the steam cools enough to turn into condensate. Then the trap opens allowing the condensate to drain from the radiator (Figure 4).

How does the steam trap know when to open and close? By temperature. The bellows inside the trap is filled with a mixture that is set to boil at a temperature slightly lower than the steam. Air will pass through the trap. When steam begins to enter through the trap, the bellows expands and closes the trap.

The trap remains closed until the steam cools and condenses into water. The bellows retracts to allow the water into the return piping.

Why not allow the steam into the return piping and simply not use a steam trap? First, you would be wasting a lot of heat and money. It would be wasted in the return piping. Second, you could be overheating areas that there is no call for heat. Third, condensate pumps can be damaged by excessive temperature in condensate.

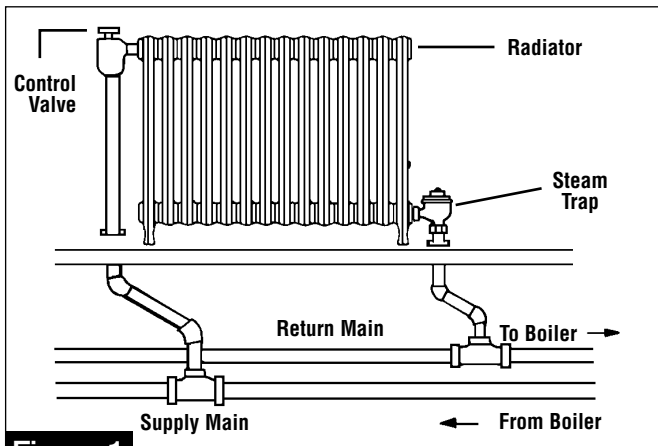

Figure 1

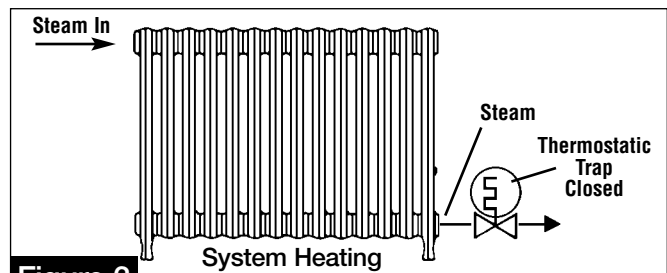

Figure 3

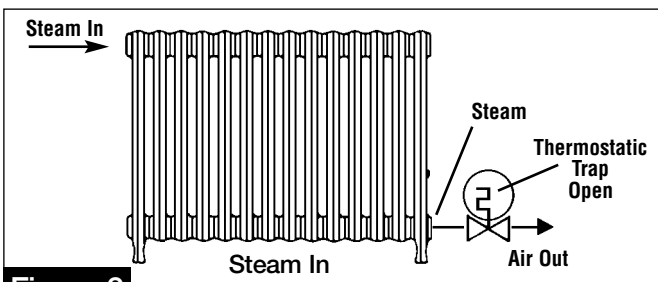

Figure 2

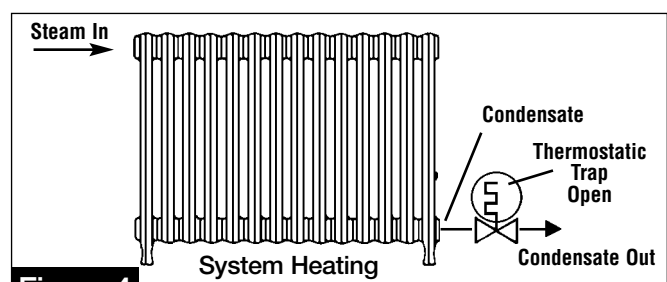

Figure 4



USA: 815 Chestnut St., No. Andover, MA 01845-6098; [www.wattsreg.com](http://www.wattsreg.com)  
 Canada: 5435 North Service Rd., Burlington, ONT. L7L 5H7; [www.wattscanada.ca](http://www.wattscanada.ca)