

For Non-Health Hazard Applications

Job Name _____

Contractor _____

Job Location _____

Approval _____

Engineer _____

Contractor's P.O. No. _____

Approval _____

Representative _____

Series 775

Double Check Valve Assemblies

Sizes: 1/2" – 2" (15 – 50mm)

Series 775 Double Check Valve Assemblies provide protection of the potable water supply for non-health hazard cross-connections. Only those cross-connections identified by local inspection authorities as non-health hazard shall be allowed the use of an approved double check valve assembly.

Features

- Tubular copper body creates smooth flow path and low headloss
- External/internal electroless nickel-plated body acts as an oxygen barrier for corrosion resistance
- Threaded-in check modules eliminate the use of check retainers for lower pressure loss
- Shortest lay length in the industry allows for the use of smaller meter boxes and enclosures
- Bolted on, top entry stainless steel single access cover for ease of maintenance in meter box installations
- Modular check construction featuring non-reversible checks with captured springs for simplified servicing
- Check valve seats are replaceable without the use of special tools
- Top mounted test cocks provide easy access for testing

Models

Suffix:

S bronze strainer

Specifications

A double check valve assembly shall be installed at each noted location. The assembly shall consist of two threaded-in check modules with captured springs and silicone seat discs. Seats and seat discs shall be replaceable without the use of special tools. Service of all internal components shall be through a single access cover secured with stainless steel bolts. The assembly shall include two nickel-plated resilient seated isolation valves and four top mounted test cocks. The assembly shall have an electroless nickel-plated tubular copper body. The assembly shall meet the requirements of ASSE Standard 1015 and AWWA Standard C510. Assembly shall be Watts Regulator Company Series 775QT.

Watts product specifications in U.S. customary units and metric are approximate and are provided for reference only. For precise measurements, please contact Watts Technical Service. Watts reserves the right to change or modify product design, construction, specifications, or materials without prior notice and without incurring any obligation to make such changes and modifications on Watts products previously or subsequently sold.

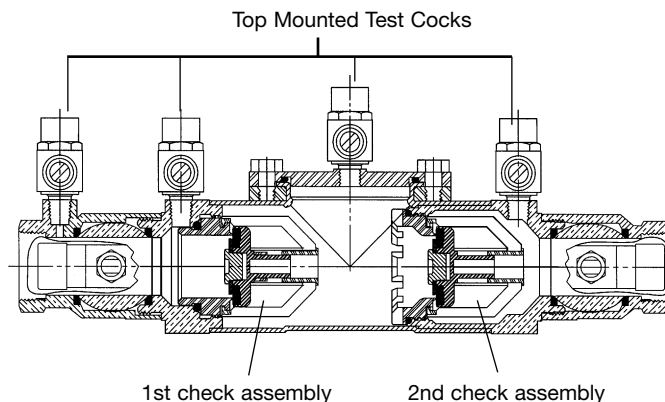
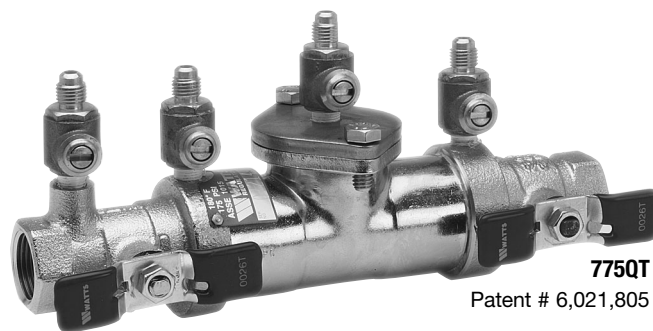

Check Module Assembly

The 775QT Series features a modular design which facilitates maintenance and assembly by retaining the spring load. Check modules are threaded into the valve adapter for leak proof operation.

Pressure – Temperature

Temperature Range: 33°F-180°F (5°C-82°C) continuous

Maximum Working Pressure: 175psi (12.06 bar)

**IMPORTANT: INQUIRE WITH GOVERNING AUTHORITIES
FOR LOCAL INSTALLATION REQUIREMENTS**

Now Available
WattsBox Insulated Enclosures.

For more information, send for literature ES-WB.

WATTS®
REGULATOR

ISO 9001
CERTIFIED

USA: 815 Chestnut St., No. Andover, MA 01845-6098; www.wattsreg.com
Canada: 5435 North Service Rd., Burlington, ONT. L7L 5H7; www.wattscanada.ca

Capacities

As compiled from documented Foundation for Cross-Connection Control and Hydraulic Research at the University of Southern California lab tests.

***Typical maximum flow rate (7.5 feet/sec.)**

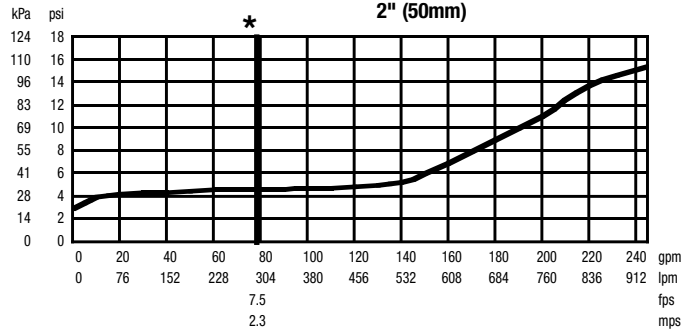
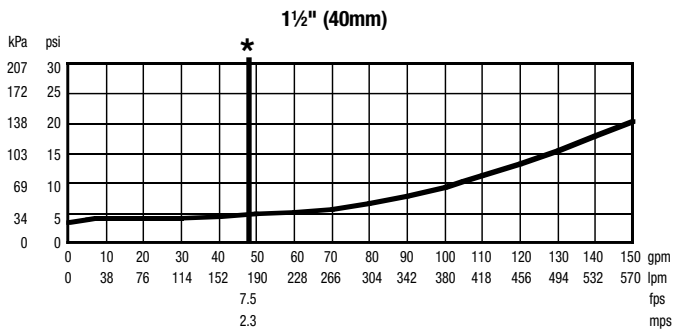
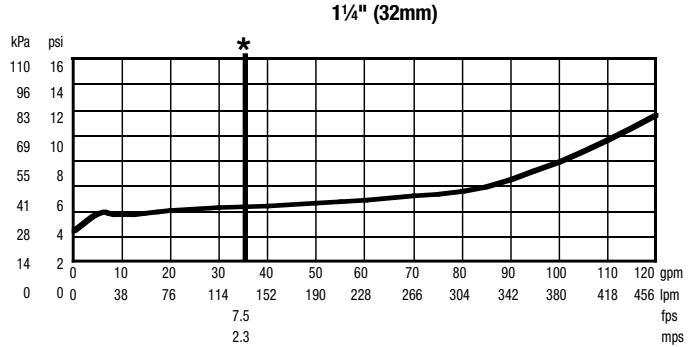
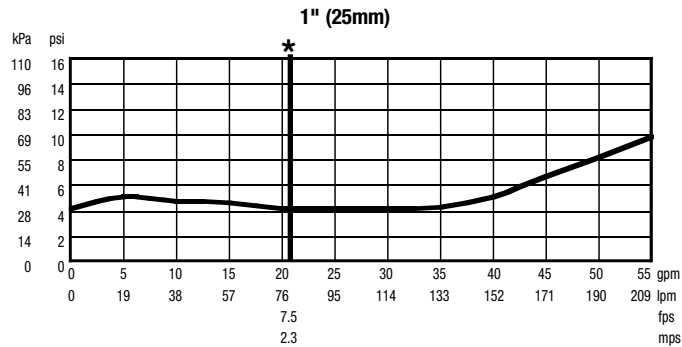
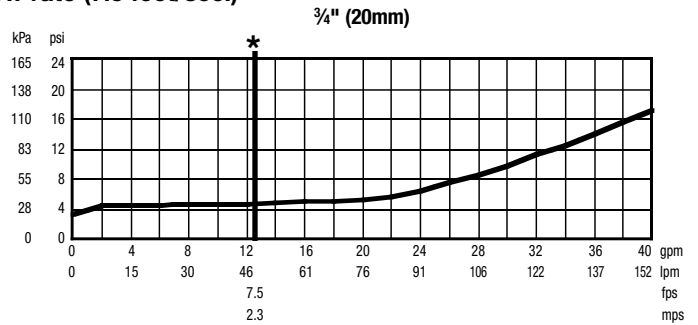
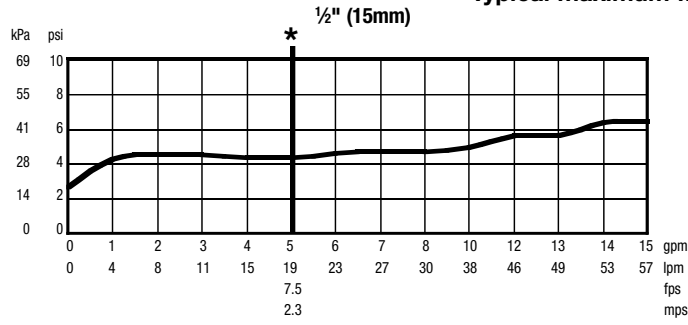

Dimensions – Weights

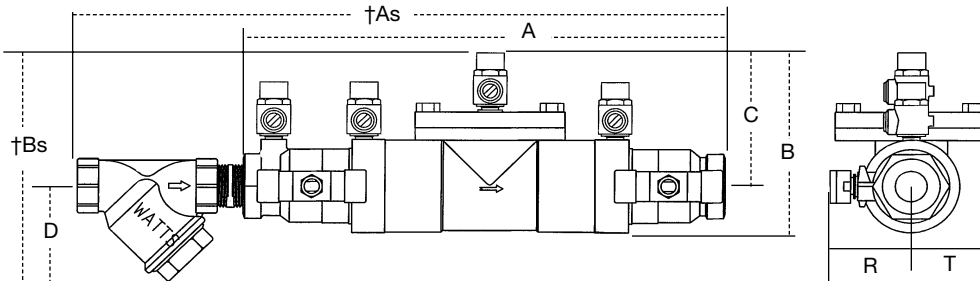

Standards

AWWA Std. C510

Approvals



MODEL	SIZE (DN)		DIMENSIONS								WEIGHT					
	in.	mm	A		B		C		D		R		T		lbs.	kg.
775QT	1/2	15	9	228	3 5/8	92	2 5/8	67	—	—	1 5/8	41	1 9/16	40	4	1.8
775QT	3/4	20	9	228	3 5/8	92	2 5/8	67	—	—	1 5/8	41	1 9/16	40	4	1.8
775QT	1	25	11 1/4	286	4 1/2	114	3 9/16	84	—	—	1 7/8	47	1 5/8	41	6.31	2.9
775QT	1 1/4	32	15 3/8	390	6	152	4 7/16	113	—	—	3 1/4	82	2 3/4	69	17	7.7
775QT	1 1/2	40	15 3/8	390	6	152	4 7/16	113	—	—	3 1/4	82	2 3/4	69	17	7.7
775QT	2	50	18 1/2	460	6	152	4 7/16	113	—	—	3 1/4	82	2 3/4	69	26	11.8
†775QT-S	1/2	15	12	304	5 5/8	143	2 5/8	67	3	76	1 5/8	41	1 9/16	40	5	2.3
†775QT-S	3/4	20	12 1/2	317	5 5/8	143	2 5/8	67	3	76	1 5/8	41	1 9/16	40	5.75	2.6
†775QT-S	1	25	16	406	6 9/16	167	3 3/16	84	3 1/4	83	2	51	1 5/8	41	8.31	3.8
†775QT-S	1 1/4	32	19 7/8	504	6	152	4 7/16	113	3 1/2	89	3 1/4	82	2 3/4	69	21	9.5
†775QT-S	1 1/2	40	20 1/4	514	6	152	4 7/16	113	4	102	3 1/4	82	2 3/4	69	22.5	10.2
†775QT-S	2	50	23 7/8	606	6	152	4 7/16	113	5	102	3 1/4	82	2 3/4	69	33.75	15.3

†Subscript "S" = strainer model