

► **Code Number**

3346095

► **Description**

The ESD-700 is part of Sloan's new line of sensor activated foam soap dispensers designed to match Sloan's electronic faucet lines. It uses a replaceable soap refill bottle with easy release collar for fast soap refill changes. The sensor technology offers a hands-free operation by delivering a pre-measured foam soap application "on demand".

► **Specifications**

Designed to match Sloan's EAF-7XX family of faucets. This sensor activated, electronic, chrome plated die cast body features:

- Modular one-piece construction is easy to install on a sink deck surface
- All electronics in spout are sealed
- Designed for drip free foam dispensing operation
- Motor Assembly suspended under counter connected to soap dispenser spout
- Motor Assembly rotates 360 degrees for easy installation
- Battery life of 45,000 activations
- 1,500 dispenses per foam soap bottle
- Ships with 2 bottles of non-scented, non-colored foam soap (1500ml per bottle)
- Additional foam soap can be purchased through Sloan (ESD-321) or GOJO distribution (8565-02-N6300GN)

► **Electrical Specifications**

- Ships with battery pack (4 "D" Alkaline batteries included)
- Optional AC adaptor can be purchased separately
- Sensor range – nominal 5"
- GFI outlet suggested per code
- 120V/15 Amp

► **Combinations**

Select the ESD-701 to combine ESD-700 soap dispenser, 2 bottles of soap and the EAF-750-ISM faucet

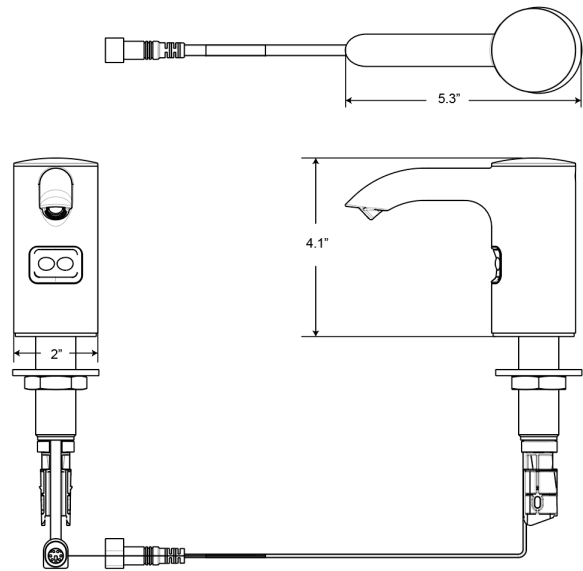

ESD-700 Soap Dispenser

► **Compliance & Certifications**



This space for Architect/Engineer Approval