



INSTALLATION INSTRUCTIONS  
**SMOOTH**<sup>™</sup>  
(SIDE-MOUNT-OPERATOR-OVER-THE-HANDLE)  
FLUSHOMETER RETROFIT KIT

**EBV-200-A SMOOTH FLUSHOMETER RETROFIT KIT INSTALLATION INSTRUCTIONS**

**NOTE: Water does not need to be shut off.**

- 1** Pull and swing Mounting Clamp to the open position.

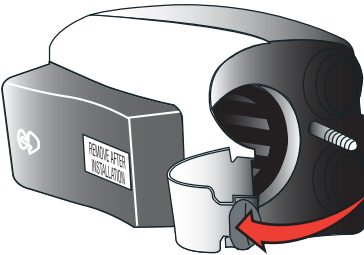

- 2** Slide the unit over the existing handle up to the flushometer body.

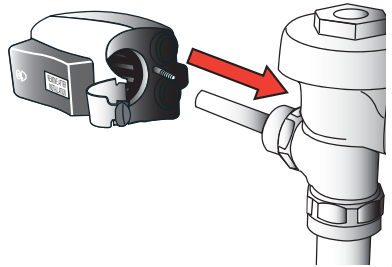

- 3** Swing the Mounting Clamp around the flushometer body and press the clamp end into the unit until it clicks into place.

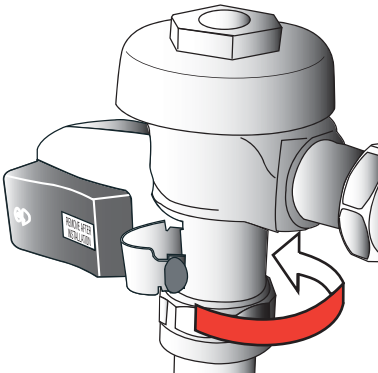

- 4** Tighten unit by pushing in on the spring loaded Mounting Screw and turning clockwise with a 1/8" hex wrench. **Do Not overtighten.**

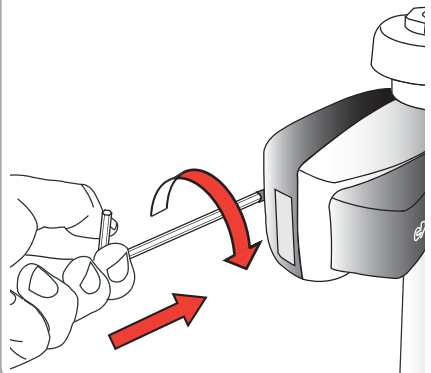

- 5** Remove Adhesive Label from sensor window.

**NOTE:** Red LED light will flash and product will cycle. Unit is now ready for use.

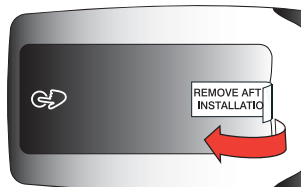

## OPERATION

### NORMAL OPERATION

When a user enters the sensor's effective range, the Red LED light in the sensor window flashes for eight seconds. After eight seconds of sensing a user, the light will stop flashing and the unit waits for the user to step away before initiating a flush cycle.

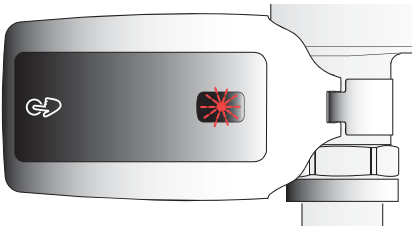

### LOW BATTERY INDICATOR

When a user enters the sensor's effective range and the Red LED light in the sensor window flashes twice as fast as normal, the batteries need replacement. Refer to the Battery Replacement Instructions on Page 4.

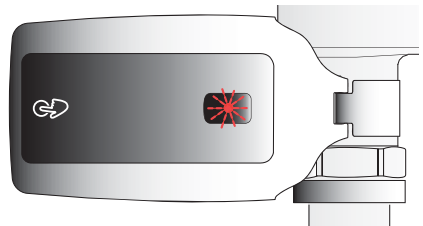

### INITIATING A MANUAL FLUSH CYCLE

A manual flush cycle may be initiated by fully pressing and releasing the Override Handle.

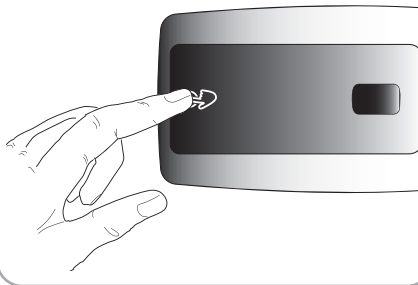

## ADJUSTMENT PROCEDURES

The SMOOTH unit is factory set with a Sentinel Flush Feature. This Feature will activate the flushometer once every 72 hours with no activity, to maintain the water seal in the fixture and conserve water. There should be no need for further adjustments; however, if an adjustment is required, refer to the following instructions.

**Note:** To make the adjustments indicated below, power to unit(s) must be turned off for ten (10) seconds. Mode selection is available within one (1) hour after every power up condition (reinstalling batteries).

### RESETTING UNIT TO NORMAL RANGE (Water Closets)

#### **Mode A**

The SMOOTH unit may be reset to normal range by fully pressing and holding in the Override Handle until the Red LED light in the Sensor Window illuminates. Then immediately release the Override Handle.

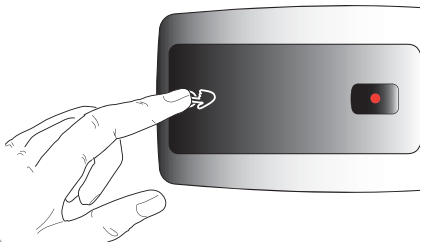

### SETTING UNIT FOR REDUCED RANGE (Water Closets)

#### **Mode B**

The SMOOTH unit may be set to reduced range for closet applications by pressing and holding in the Override Handle until the Red LED light in the Sensor Window illuminates. Then immediately release the Override Handle.

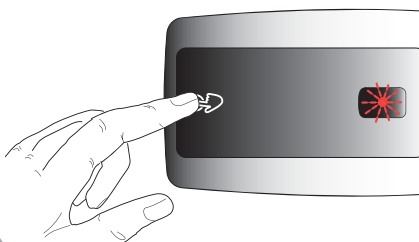

### SETTING UNIT TO REDUCED RANGE (Typically for Urinals)

#### **Mode C**

The SMOOTH unit may be set to reduced range by pressing and holding in the Override Handle until the Red LED light in the Sensor Window displays a rapid on and off blinking light. Then immediately release the Override Handle.

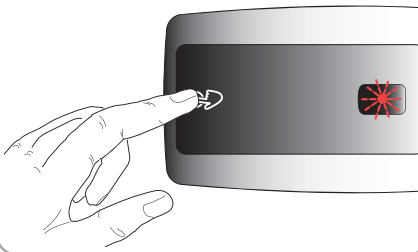

## MAINTENANCE PROCEDURES

### BATTERY REPLACEMENT INSTRUCTIONS

NOTE: Water does not need to be shut off.

- 1 Release Mounting Clamp by turning the Mounting Screw counterclockwise with a 1/8" hex wrench.

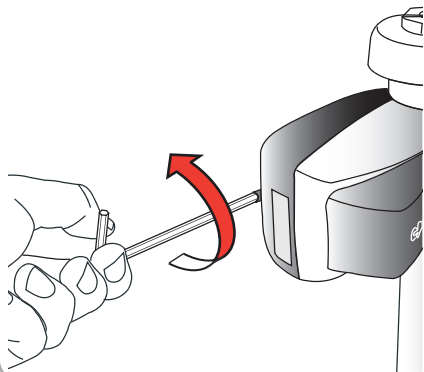

- 2 Swing the Mounting Clamp into the open position.

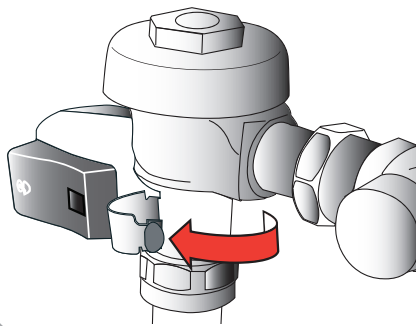

- 3 Slide the unit from the flushometer body.

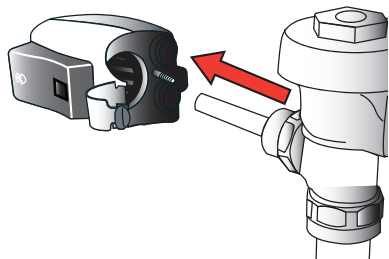

- 4 Open Battery Compartment Door and remove old batteries from unit. Replace batteries with 4 (four) new C-size batteries. Close Battery Compartment Door. Reinstall unit as instructed on front page.

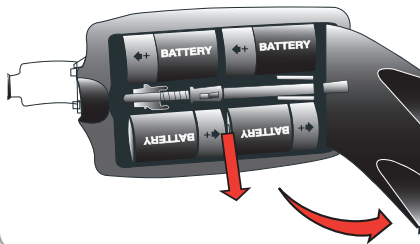

NOTICE: The information contained in this document is subject to change without notice.

If further assistance is required, please contact the Air Delights, Inc. Installation Engineering Department at:

1-800-440-5556 or email [customer\\_service@airdelights.com](mailto:customer_service@airdelights.com)

#### LIMITED WARRANTY

Sloan Valve Company warrants its OPTIMA SMOOTH™ EBV-200-A unit to be made of first class materials, free from defects of workmanship under normal use and to perform the service for which it is intended in a thoroughly reliable and efficient manner. It is not intended to be used for any other purpose. Sloan Valve Company will, at its option, repair or replace any parts which prove to be thus defective if returned to Sloan Valve Company, at customer's cost, and this shall be the sole remedy available. No claims will be allowed for labor, transportation or other incidental costs. This warranty extends only to persons or organizations that purchase Sloan Valve Company's products directly from Sloan Valve Company for purpose of resale. This warranty does not cover the life of the batteries.

THERE ARE NO WARRANTIES WHICH EXTEND BEYOND THE DESCRIPTION ON THE FACE HEREOF. IN NO EVENT IS SLOAN VALVE COMPANY RESPONSIBLE FOR ANY CONSEQUENTIAL DAMAGES OF ANY MEASURE WHATSOEVER.

**SLOAN**

Copyright © 2007 SLOAN VALVE COMPANY

Air Delights, Inc. • 11170 SW 5th St., Ste. 100, Beaverton, OR 97005  
Phone: 1-800-440-5556 or email: [customer\\_service@airdelights.com](mailto:customer_service@airdelights.com)

[www.airdelights.com](http://www.airdelights.com)

07-07