

CODE NUMBER

3400216

DESCRIPTION

1.6 gpf, Filtered, Rough Brass Finish, Black Wall Plate Finish, Single Flush, Integrated Control Stop, 3.25-4.25 L Dimension, Adjustable Flush Connection Outlet Tube, ADA Compliant Push Button, Short V500A & Adjustable Flush Connection Vacuum Breaker, Front Accessible Wall Box, CX Concealed Manual Water Closet Flushometer.

DETAILS

- Flush Volume: 1.6 gpf (6.0 Lpf)
- Finish: Rough Brass (RB)
- Wall Plate Finish: Black (BLK)
- Valve: Piston
- Bypass: Filtered
- Valve Body Material: Semi-red Brass
- Fixture Type: Water Closet
- Fixture Connection: Rear
- Rough-In Dimension: 12 3/8" (321mm)
- Spud Coupling: 1 1/2" (38mm)
- Supply Pipe: 1" (25mm)
- L Dimension: 3 1/4" - 4 1/4" (83-108mm)
- Wall Box: Front Accessible
- Push Button: ADA Compliant
- Control Stop: Integrated
- Vacuum Breaker: Short V500A & Adjustable Flush Connection
- Outlet Tube: Adjustable Flush Connection

FEATURES

- Fixed volume piston with filtered O-ring bypass
- Front access wall plate requires no rear access plumbing chase
- ADA compliant push button
- Vandal resistant wall plate
- Adjustable flush connection

VIDEOS

- ▶ CX Flushometer Product Video
- ▶ CX Flushometer - Manual Installation
- ▶ CX Flushometer - Manual Vacuum Service
- ▶ CX Flushometer - Manual Piston Service
- ▶ CX Flushometer Product Video (Spanish)

**RECOMMENDED SPECIFICATION**

Valve shall be concealed with front access plate smaller than 10" x 10" and shall have integrated control stop. Valve body shall be in compliance with ASTM Alloy Classification for Semi-Red Brass. Valve shall be in compliance to the applicable sections of ASSE 1037.

VALVE OPERATING PRESSURE (FLOWING)

20-80 PSI (138-552 kPa). Specific fixtures may require greater minimum flowing pressure - consult manufacturer requirements.

DOWNLOADS

- [CX 158 / 198 Installation Instructions](#)
- [CX 158 / 198 Repair and Maintenance Guide](#)
- [Additional Downloads](#)

NOTES

All information contained within this document subject to change without notice.

Looking for other variations of the CX 158 product? [View the general spec sheet with all options.](#)

[Find a compatible urinal](#) for this flushometer.

[Find a compatible water closet](#) for this flushometer.

Sloan 10500 Seymour Ave, Franklin Park, IL 60131

Phone: 800.982.5839 • Fax: 800.447.8329 • sloan.com

ROUGH-IN

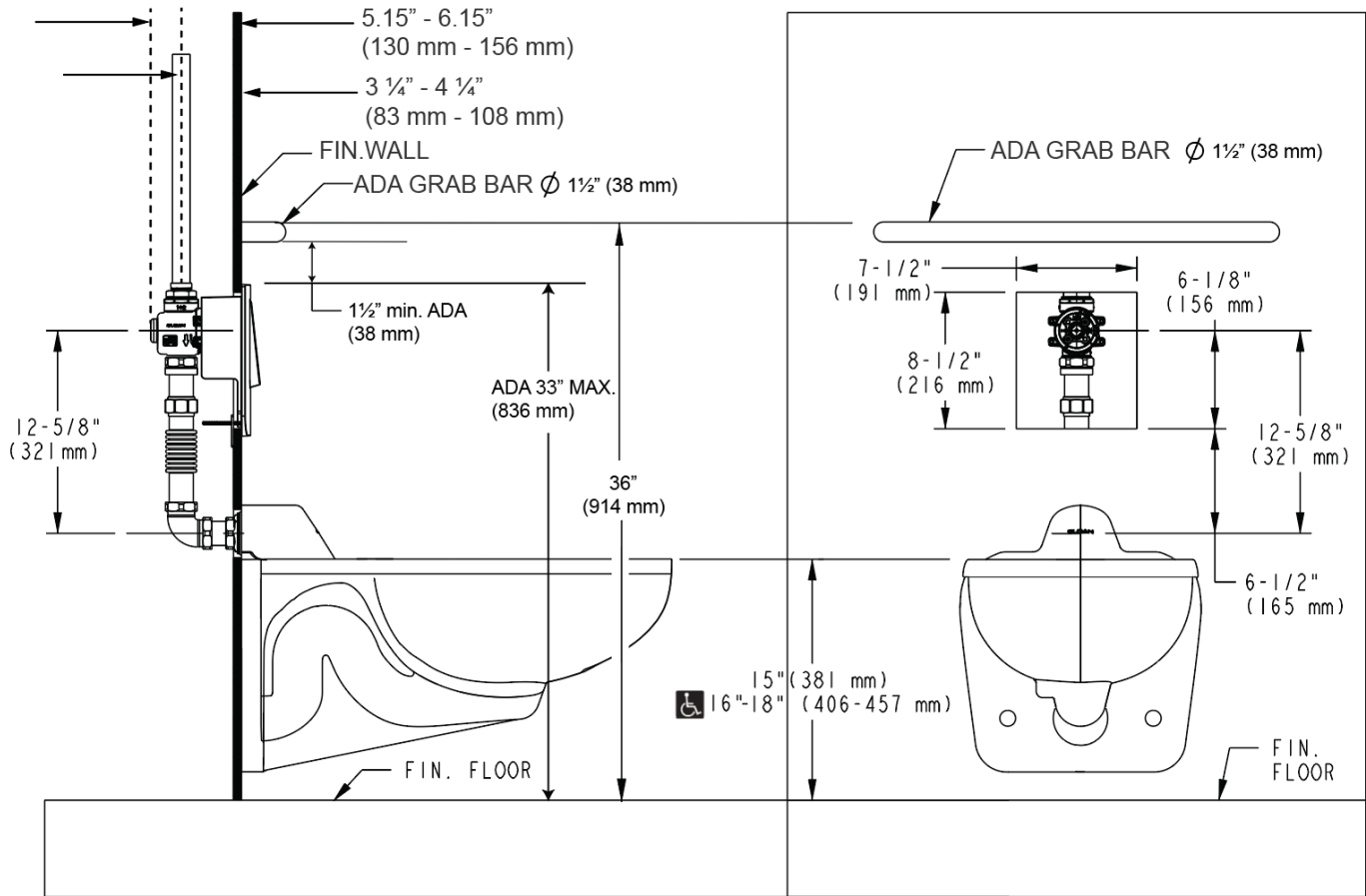

Sloan 10500 Seymour Ave, Franklin Park, IL 60131
 Phone: 800.982.5839 • Fax: 800.447.8329 • sloan.com