

**8190
(CONCEALED LATCH)**

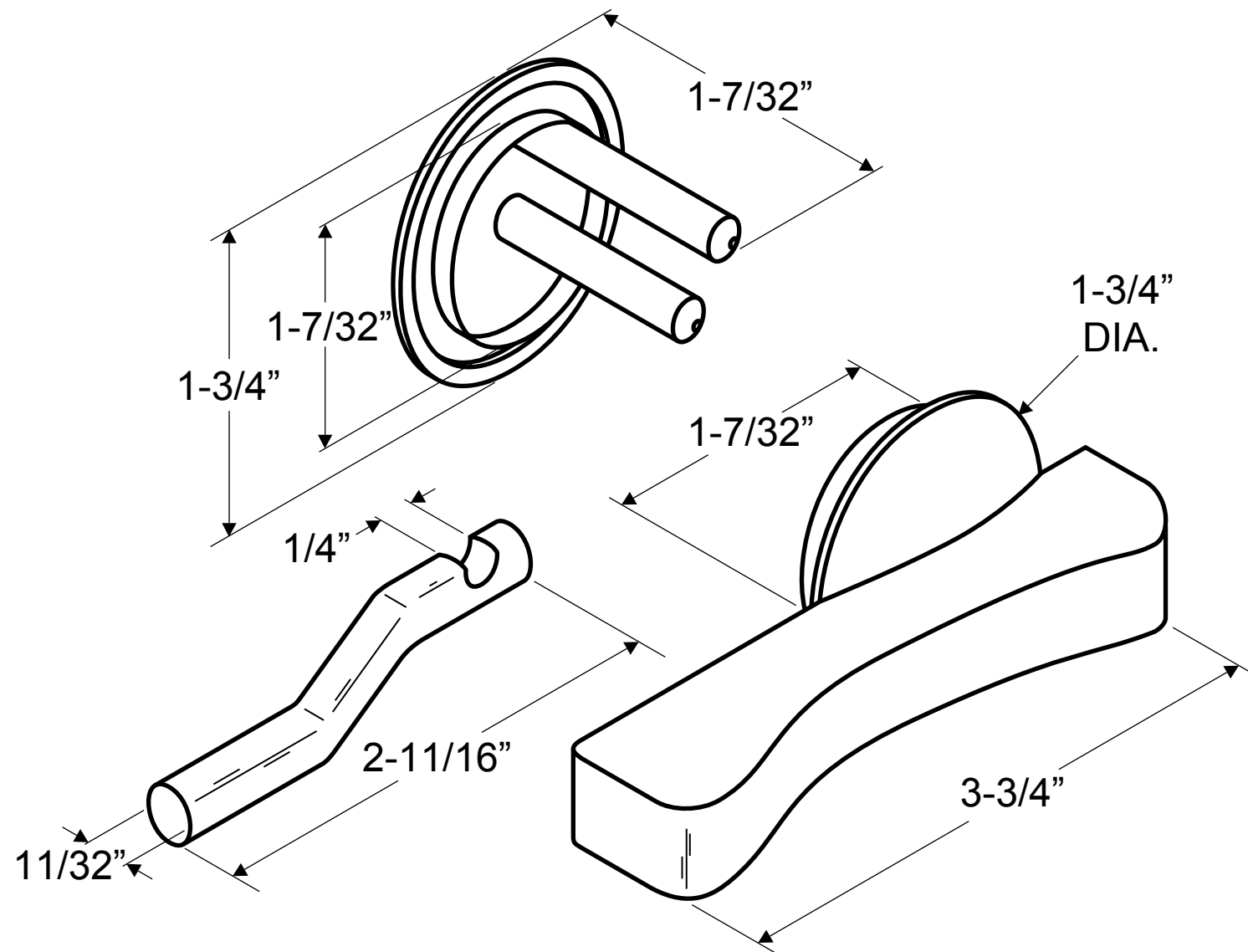

**NOTE: LATCH CAN BE USED
WITH ADA DOORS**

**INSTRUCTIONS FOR INSTALLING
5190, 6190, 8190 CONCEALED LATCHES**

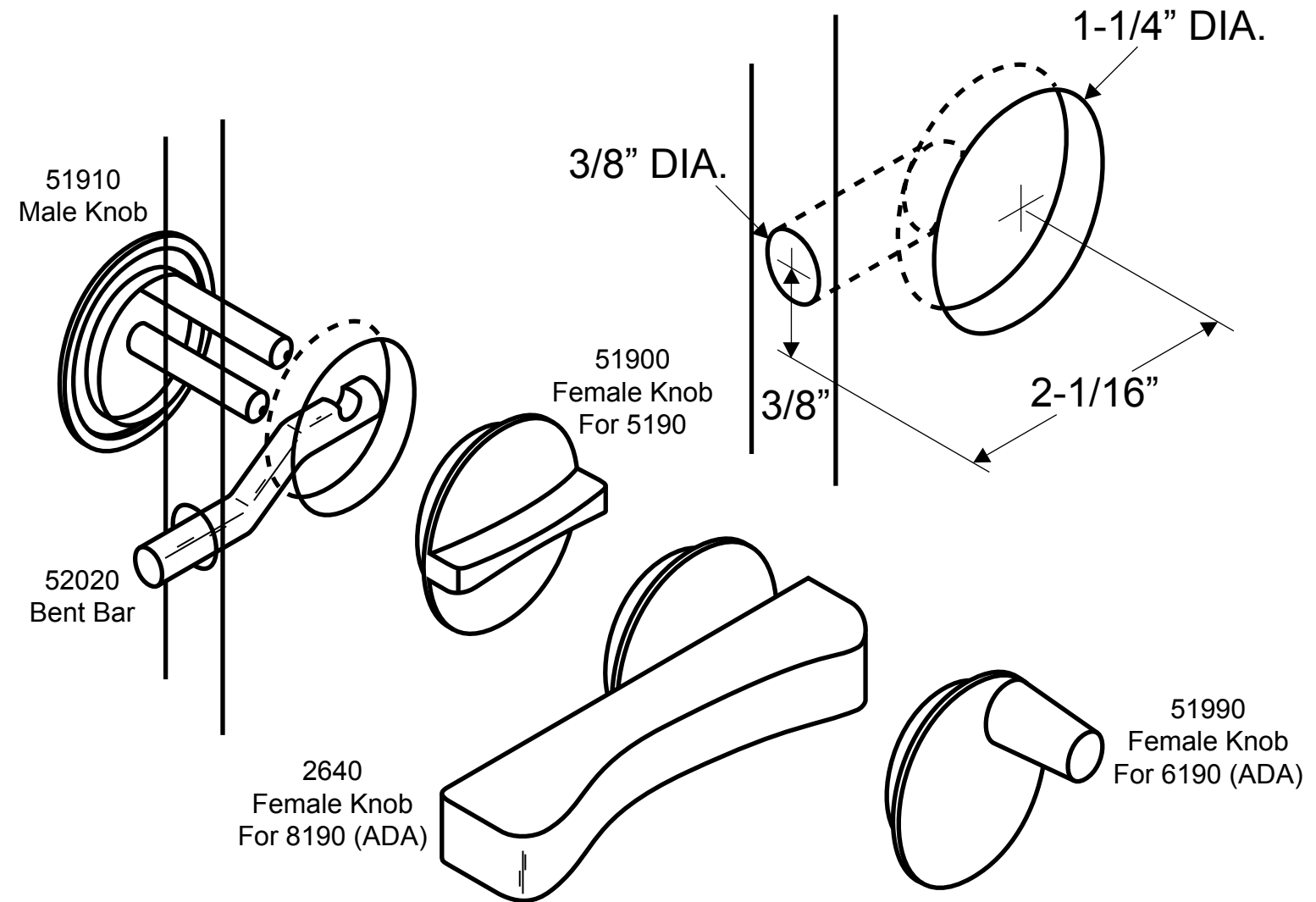

- 1. Insert bar through edge of door - notched end first.**
- 2. Insert male knob in door, engage upper pin of knob into notch of straight pin.**
- 3. Insert female knob - engage both pins of male knob, hold one knob and apply pressure to the other to engage retainer ring.**

REMOVAL - To remove latch, drill 3/8" diameter hole through center of female knob 5/8" deep. Pull knob set apart.