

**4040, 4041, 4043
(PIVOT HINGE - BOTTOM 1-1/4")**

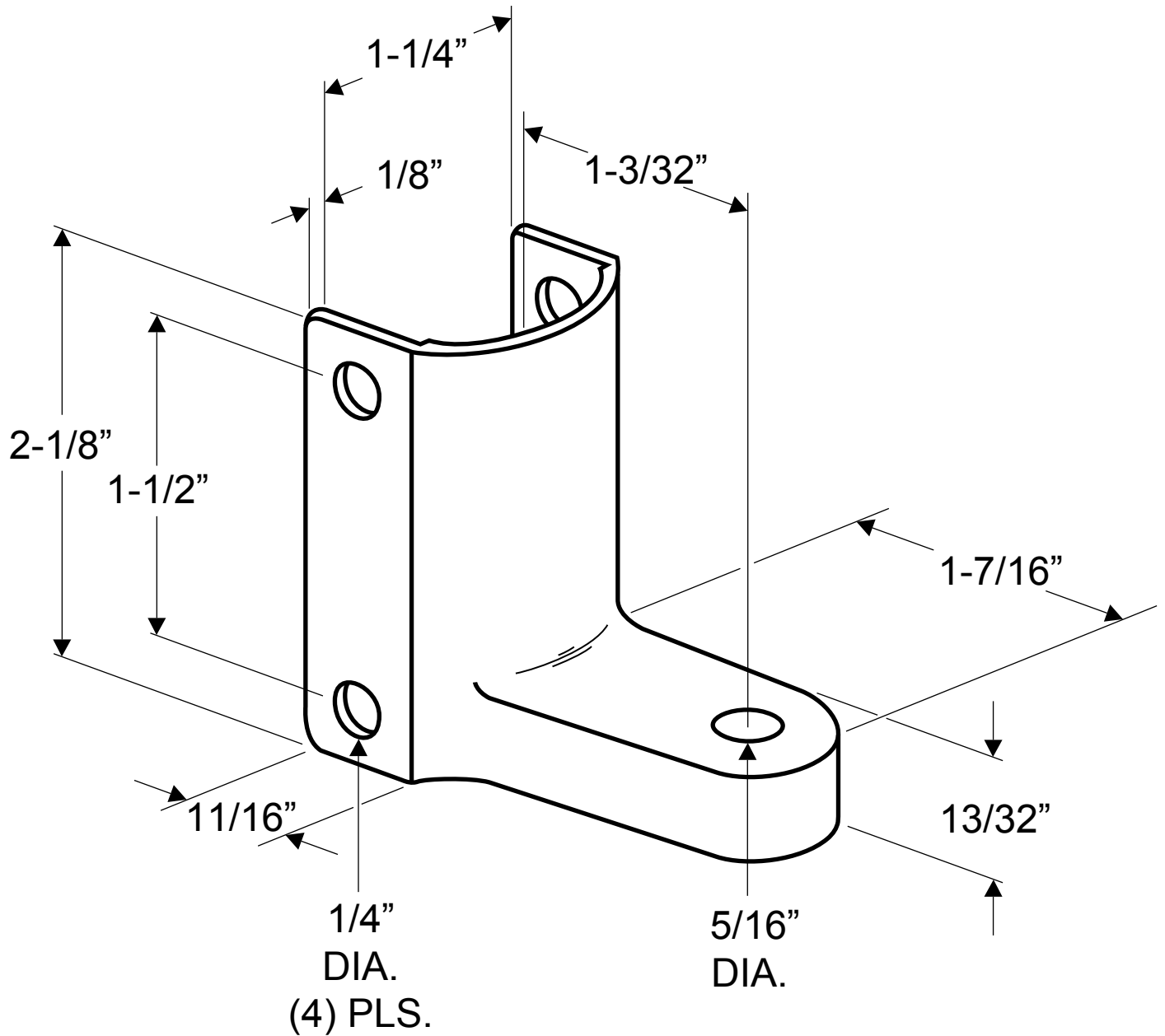

NOTE: USED WITH 4530, 4531, 4533 TOP HINGE