

**5060, 5061, 5062, 5063
(SLIDE LATCH)**

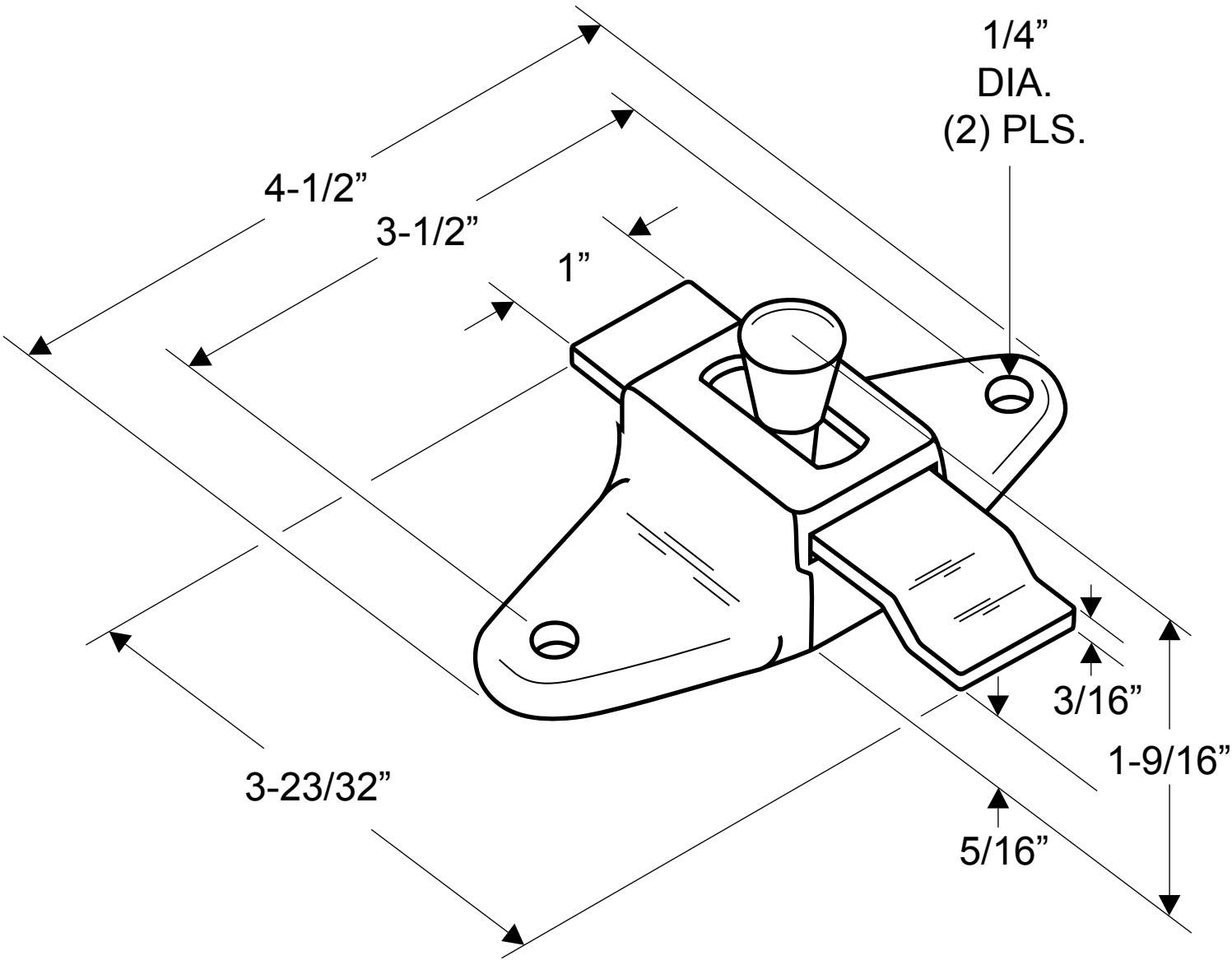

**NOTE: STANDARD FOR 5400 DOOR PULL
SLIDE DISTANCE $\frac{15}{16}$ "**