

2888
(WALL BRACKET - TWO EAR 1"x41")

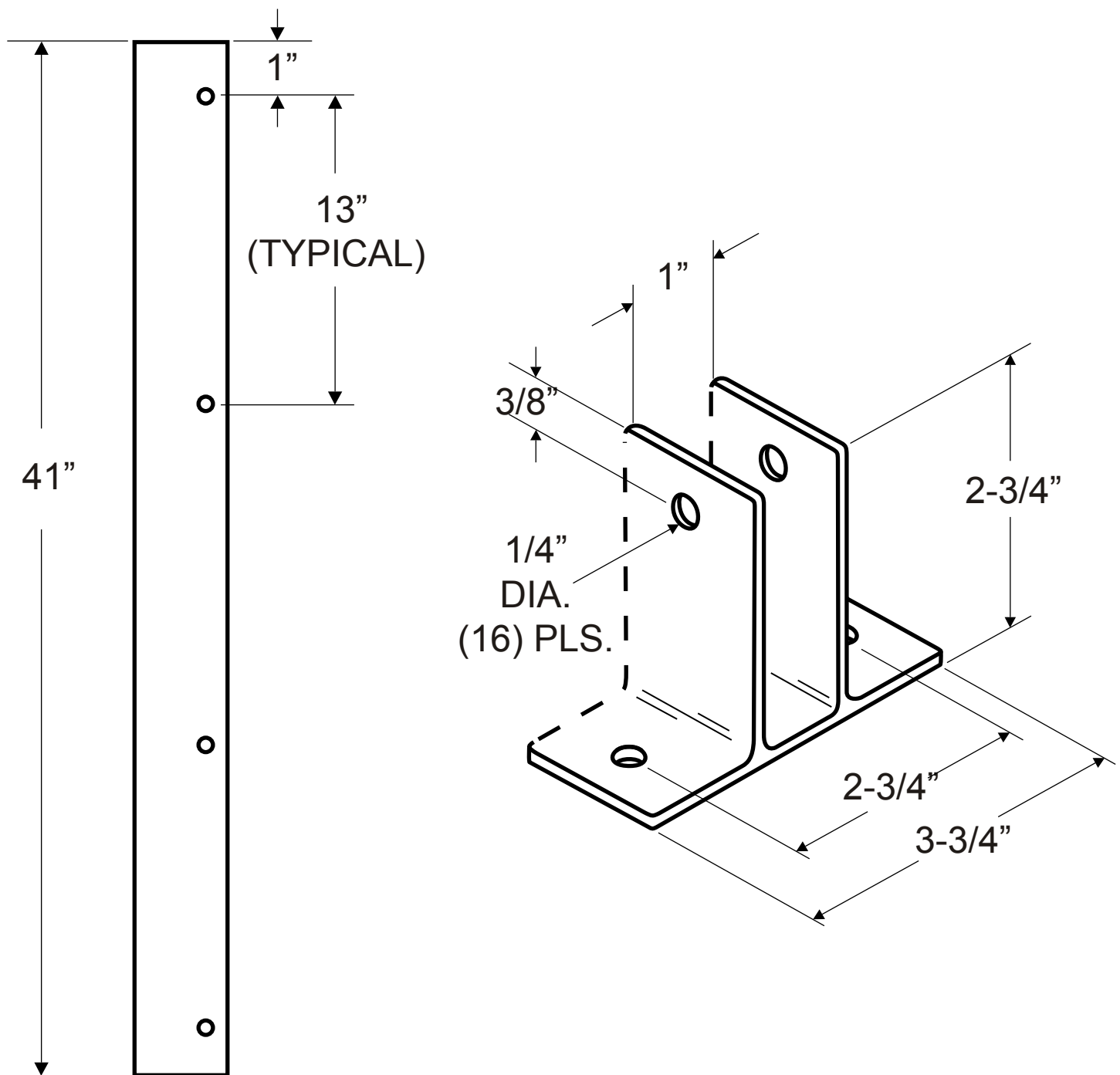

NOTE: ALL WALL THICKNESS AT 1/8"