



S19314SBFW, S19314BF, S19314TT

Combination Drench Shower and Halo™ Eye/Face Wash with Stainless Steel Bowl

- Halo™ and SpinTec™ Deliver the Most Effective Shower and Eye/Face Washdown Coverage and Spray Pattern
- Exceeds ANSI/ISEA Z358.1 Specifications
- Exceeds European EN 15154-2 and EN 15154-1
- Industry's Only Self-Draining Design – The Aquaduct™
- Separate Supply and Waste Pipes – Meets CEN and Plumbing Requirements
- Ergonomic Hand Activation Eyewash Paddle – Easy to Reach from Any Direction
- Fully-Assembled and Factory-Tested Eye/Face Wash with Hinged Dust Covers
- Barrier Free Options Are Available (S19314BF)
- Universal Identification Sign and Inspection Tag Included
- Classified by Underwriters Laboratories Inc. to ANSI/ISEA Z358.1.
- Listed by Intertek to EN 15154-2 and EN 15154-1
- SpinTec showerheads are covered by one or more of the following patents: 8113446; D594,089; D669,555; Reg. Comm. Des. D001079560-0001. Other patents pending.
- Halo is Covered by One or More of the Following Patents: D662,220; D662,219; D685,920. Other Patents Pending.



Specifications

Standard and Barrier-Free Combination Drench Shower Eye/Face Wash Units save space and fit easily into any work environment. Shower valve operates quickly by a pull rod with a triangular handle. Shower provides a superior washdown with a more even spray pattern. Halo eye/face wash, operated by an ergonomic, highly visible push handle, provides effective wash down coverage and spray pattern. Integral strainer reduces debris in the water and also prevents clogging.

This plumbing fixture is not intended to dispense water for human consumption through drinking or for preparation of food or beverages.

Pipe and Fittings

1/4" piping assembly manufactured of the following material:

- Galvanized steel with BradTect® safety yellow coating

Ball Valve

1" shower ball valve and 1/2" stay-open eye/face wash valve manufactured of the following materials and supplied with type 304 stainless steel pull rod and handle:

- Chrome-plated brass

SpinTec™ Showerhead

Standard showerhead is 3.1" (78.7mm) diameter highly visible yellow impact-resistant plastic. 10 3/4" (273mm) diameter corrosion-resistant stainless steel shroud (S19314TT). SpinTec drench showerhead features integral 22 GPM (83.3 L) flow control (exceeds minimum water flow of 20 GPM (75.7L) at 30 PSI (2.0 bar)), conserving water and helping to accurately size your tepid water system.

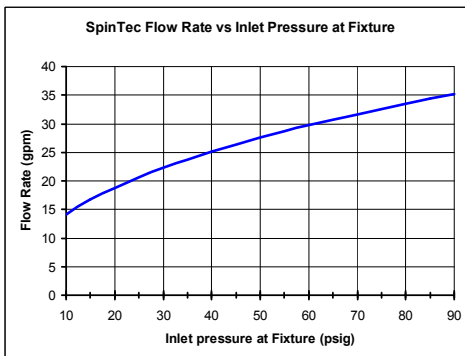

Eye/Face Wash

The Halo eye/face wash system offers a high performance rinsing platform that provides rapid relief to an individual's eyes and face that have been injured by chemicals or particulate. This system provides the most complete face wash available in the market. The eye/face wash includes an integral 5.1 GPM (19.2 L) flow control, providing water at a safe velocity while maintaining its effectiveness (exceeds minimum water flow of 3.0 GPM (11.4 L) at 30 PSI (2.0 bar)). The eye/face wash is protected by flip open dust covers that open when the product is activated by type 304 stainless steel push handle. Safe, steady water flow under varying water supply conditions from 30–90 PSI (2.0–6.1 bar) is assured by integral flow control in the sprayhead assembly. Sprayheads are made from an impact resistant ABS plastic.

Bowl

Bowl is constructed of Type 304 corrosion-resistant stainless steel.

For information on all available S19314 models, please see tech data document Bradley_SafetyCombi_S19314Series.

Model	Description
<input type="checkbox"/> S19314SBFW	Halo eye/face wash, plastic showerhead, stainless steel bowl
<input type="checkbox"/> S19314TT	Halo eye/face wash, plastic showerhead w/ stainless steel shroud & bowl
<input type="checkbox"/> S19314BF	Halo eye/face wash, barrier-free, plastic showerhead, stainless steel bowl

Tepid Water Options

Navigator S19-2100 EFX25
Emergency Thermostatic Mixing Valve



Keltech® SNA-Series
Tankless Water Heater

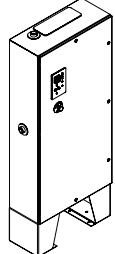

NAVIGATOR

Satisfies ANSI/ISEA Z358.1 tepid water requirements.



S19314SBFW, S19314BF, S19314TT

Combination Drench Shower and Halo™ Eye/Face Wash with Stainless Steel Bowl

S19314 shown with Stainless Steel Bowl

Drawing depicts Eyewash. Eye/Face Wash dimensions are the same.

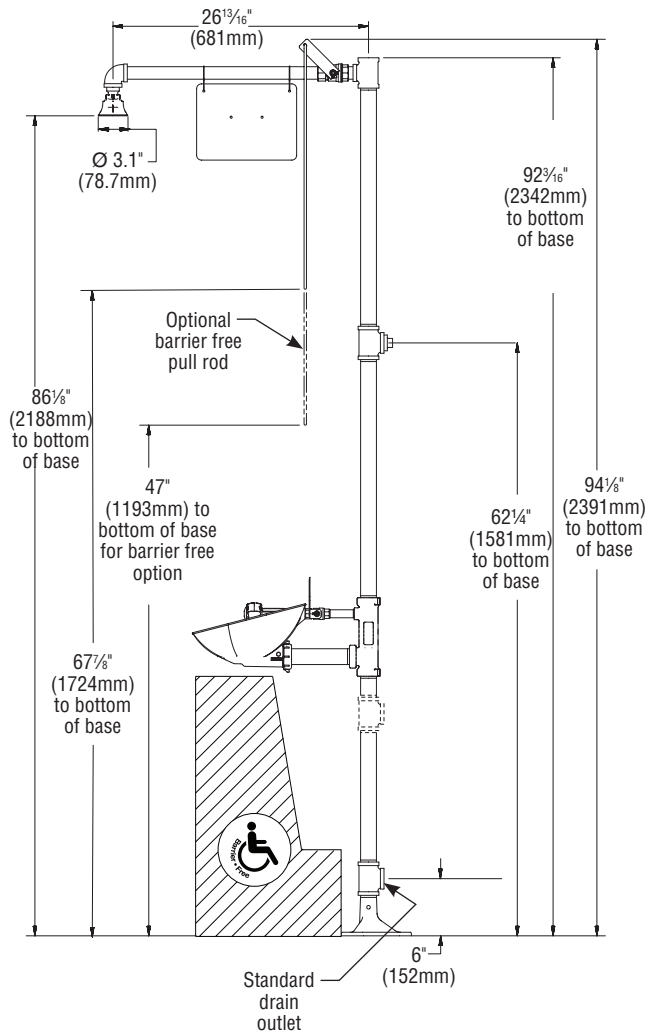

Plastic Showerhead with Stainless Steel Shroud

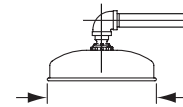

Stainless Steel $\text{Ø } 10\frac{3}{4}"$ (273mm)

Eye/Face Wash Bowl

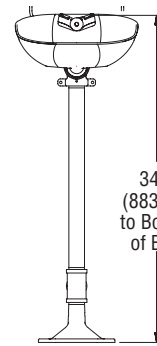
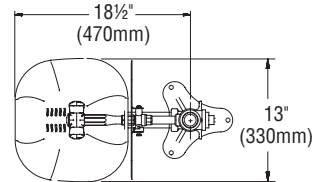

$34\frac{3}{4}"$ (883mm) to Bottom of Base

All dimensions assume standard thread engagement. Variations in manufacturing allow for $\pm \frac{1}{8}"$ (3mm) per threaded joint. To find the tolerance of a dimension, add the number of thread joints across the length of the dimension and multiply it by $\frac{1}{8}"$ (3mm).