

AIR FRESHENER AEROSOL 7oz

Installation Instructions

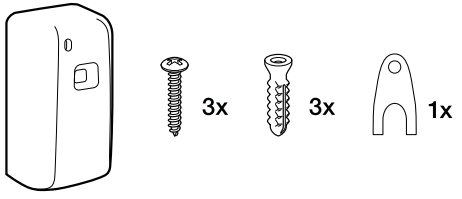

Recommended Installation Height

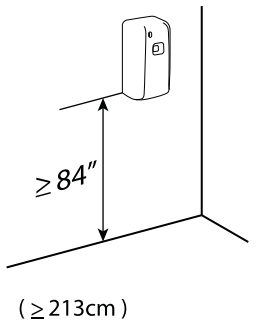

Open Dispenser

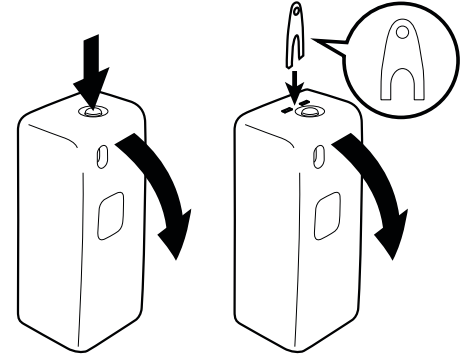

Light Indicator

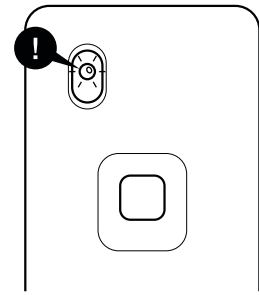

Operating: blinking green

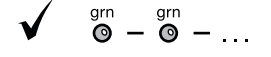

Bottle Empty: blinking red

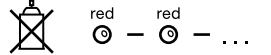

Battery Low: no light

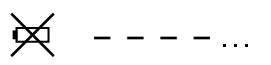

Installation with Screws

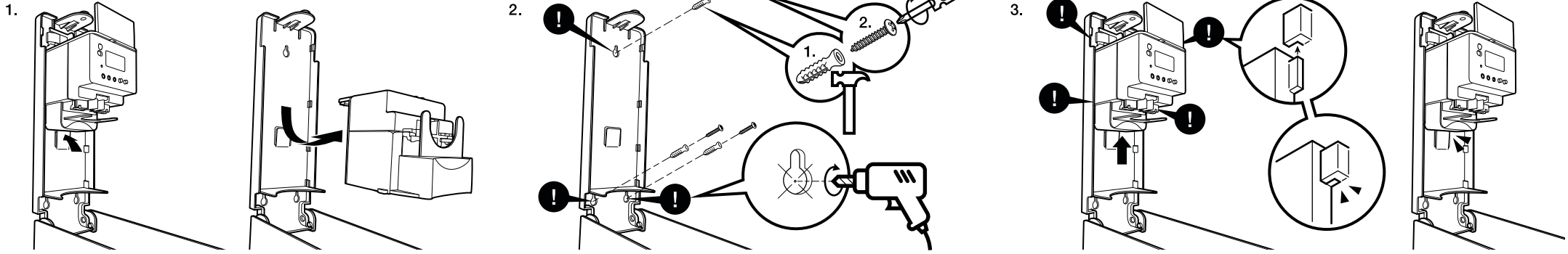

Install w/ Adhesive Backing (no screws)

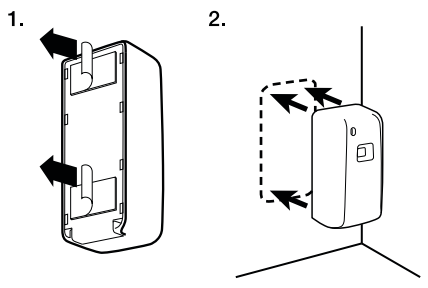

Install Cartridge

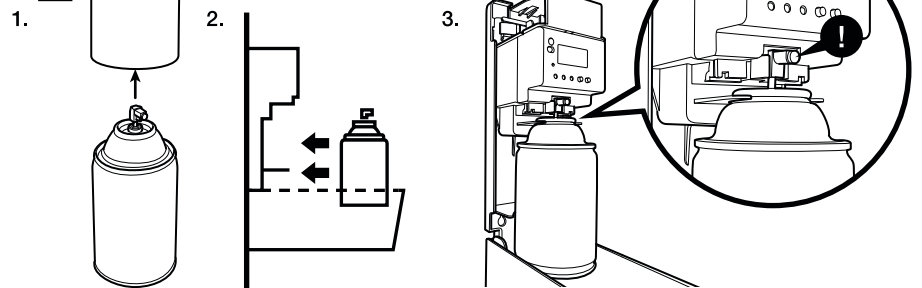

Install Batteries

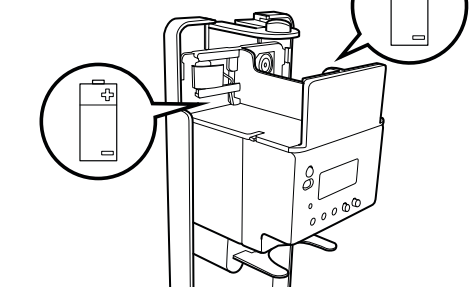

AIR FRESHENER AEROSOL 7oz

Standard Settings

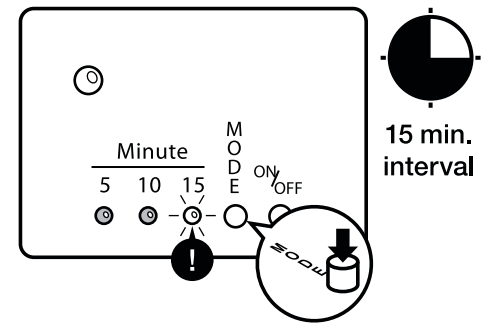
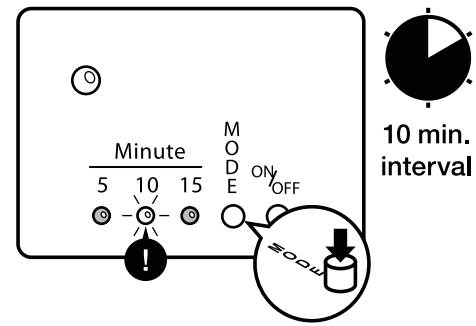
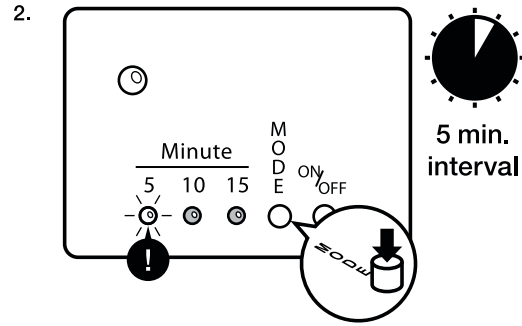
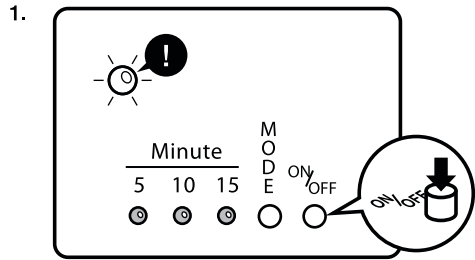

Program Settings

1. Set Day & Clock

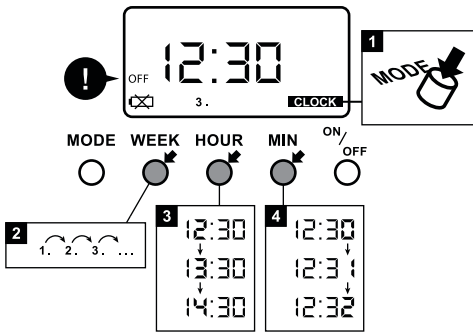

2. Spray Start Time

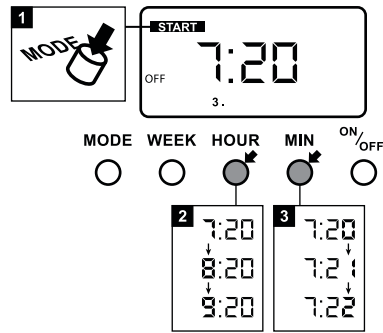

3. Spray End Time

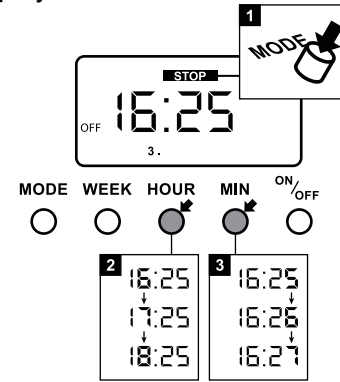

4. Spray Interval

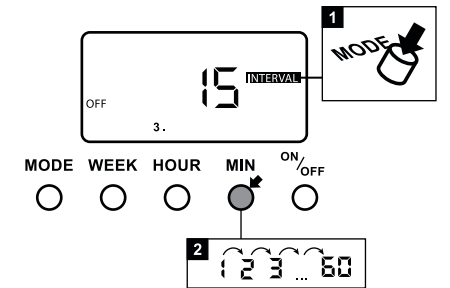

5. Days Per Week

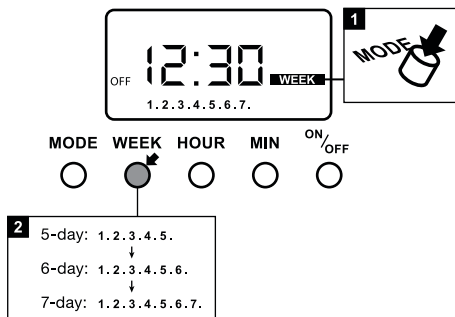

6. Program On

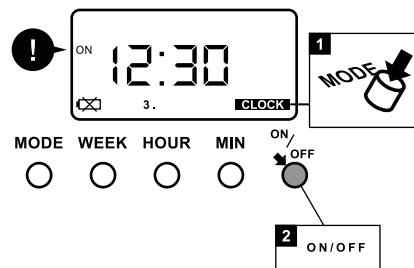

Check Spray History

