



T&S BRASS AND BRONZE WORKS, INC.
 2 Saddleback Cove / P.O. Box 1088
 Travelers Rest, SC 29690

Model No.
HG-4 Series

Item No.

Travelers Rest, SC: 800-476-4103 • Simi Valley, CA: 800-423-0150 • Fax: 864-834-3518 • www.tsbrass.com

This Space for Architect/Engineer Approval

Job Name _____ Date _____

Model Specified _____ Quantity _____

Customer/Wholesaler _____

Contractor _____

Architect/Engineer _____

SAFE·T·LINK

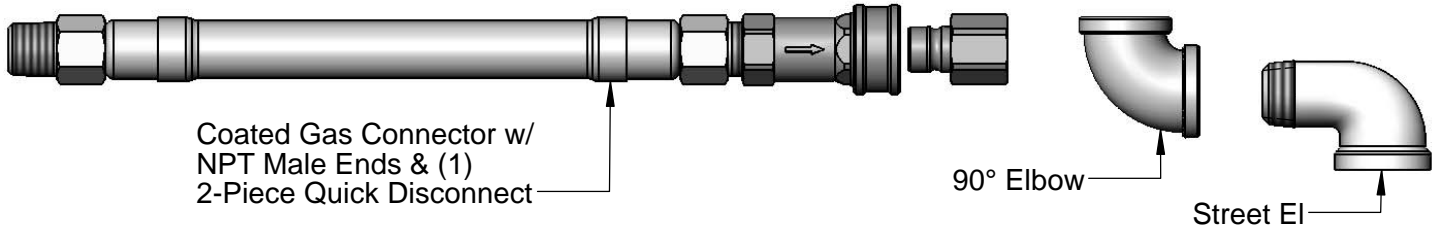

Coated Gas Connector w/
 NPT Male Ends & (1)
 2-Piece Quick Disconnect

90° Elbow

Street El

"L" = Length	1/2" NPT
12"	HG-4C-12
24"	HG-4C-24
36"	HG-4C-36
48"	HG-4C-48
60"	HG-4C-60
72"	HG-4C-72

"L" = Length	3/4" NPT
12"	HG-4D-12
24"	HG-4D-24
36"	HG-4D-36
48"	HG-4D-48
60"	HG-4D-60
72"	HG-4D-72

"L" = Length	1" NPT
12"	HG-4E-12
24"	HG-4E-24
36"	HG-4E-36
48"	HG-4E-48
60"	HG-4E-60
72"	HG-4E-72

"L" = Length	1 1/4" NPT
12"	HG-4F-12
24"	HG-4F-24
36"	HG-4F-36
48"	HG-4F-48
60"	HG-4F-60
72"	HG-4F-72

HG-4 Series Product Configurator: HG - 4 -

Ex: HG - 4 -

Gas Hose, 3/4" NPT Male Ends, 36" Length, (1) 2-Piece
 Quick Disconnect, (1) Elbow, (1) Street El

Product Specifications:

Safe-T-Link Gas Appliance Connector:
 Coated Hose w/ NPT Male Ends, 2-Piece Quick Disconnect,
 90° Elbow & Street El

Drawn:

DHL

Checked:

DMH

Approved:

JHB

Scale:

NTS

Date:

09/27/12



T&S BRASS AND BRONZE WORKS, INC.
 2 Saddleback Cove / P.O. Box 1088
 Travelers Rest, SC 29690

Model No.
HG-4-K Series

Item No.

Travelers Rest, SC: 800-476-4103 • Simi Valley, CA: 800-423-0150 • Fax: 864-834-3518 • www.tsbrass.com

This Space for Architect/Engineer Approval

Job Name _____ Date _____

Model Specified _____ Quantity _____

Customer/Wholesaler _____

Contractor _____

Architect/Engineer _____

SAFE·T·LINK

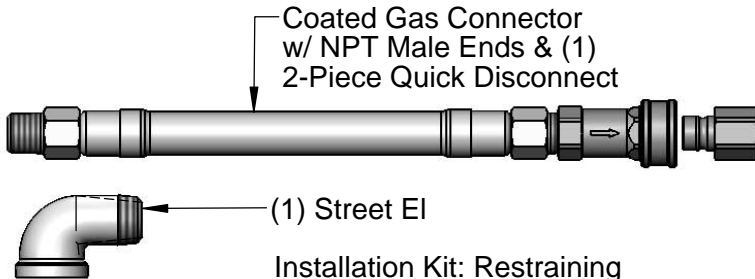

Coated Gas Connector
 w/ NPT Male Ends & (1)
 2-Piece Quick Disconnect

(1) Street EI

Installation Kit: Restraining
 Cable, Street EI, Ball Valve

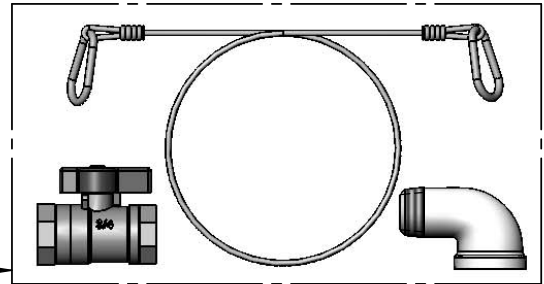

"L" = Length	1/2" NPT
12"	HG-4C-12K
24"	HG-4C-24K
36"	HG-4C-36K
48"	HG-4C-48K
60"	HG-4C-60K
72"	HG-4C-72K

"L" = Length	3/4" NPT
12"	HG-4D-12K
24"	HG-4D-24K
36"	HG-4D-36K
48"	HG-4D-48K
60"	HG-4D-60K
72"	HG-4D-72K

"L" = Length	1" NPT
12"	HG-4E-12K
24"	HG-4E-24K
36"	HG-4E-36K
48"	HG-4E-48K
60"	HG-4E-60K
72"	HG-4E-72K

"L" = Length	1 1/4" NPT
12"	HG-4F-12K
24"	HG-4F-24K
36"	HG-4F-36K
48"	HG-4F-48K
60"	HG-4F-60K
72"	HG-4F-72K

HG-4-K Series Product Configurator: HG - 4 - K

Ex: HG - 4 - K

Gas Hose, 3/4" NPT Male Ends, 36" Length, (1) 2-Piece Quick Disconnect,
 (1) Street EI, (1) Installation Kit

Product Specifications:
Safe-T-Link Gas Appliance Connector:
 Coated Hose w/ NPT Male Ends, 2-Piece Quick Disconnect,
 Street EI & Installation Kit

Drawn:	Checked:	Approved:
DHL	DMH	JHB
Scale:	Date:	
NTS	09/27/12	



T&S BRASS AND BRONZE WORKS, INC.

2 SADDLEBACK COVE / P.O. BOX 1088 / TRAVELERS REST, SC 29690

PHONE 800-476-4103

FAX 864-834-3518



REG.#A2601
ISO #9002

Model No.

HG-4E-48-RC

Item No.:

Job Name:

Architect/Engineer Approval:



AGA DESIGN CERTIFIED GAS APPLIANCE CONNECTORS

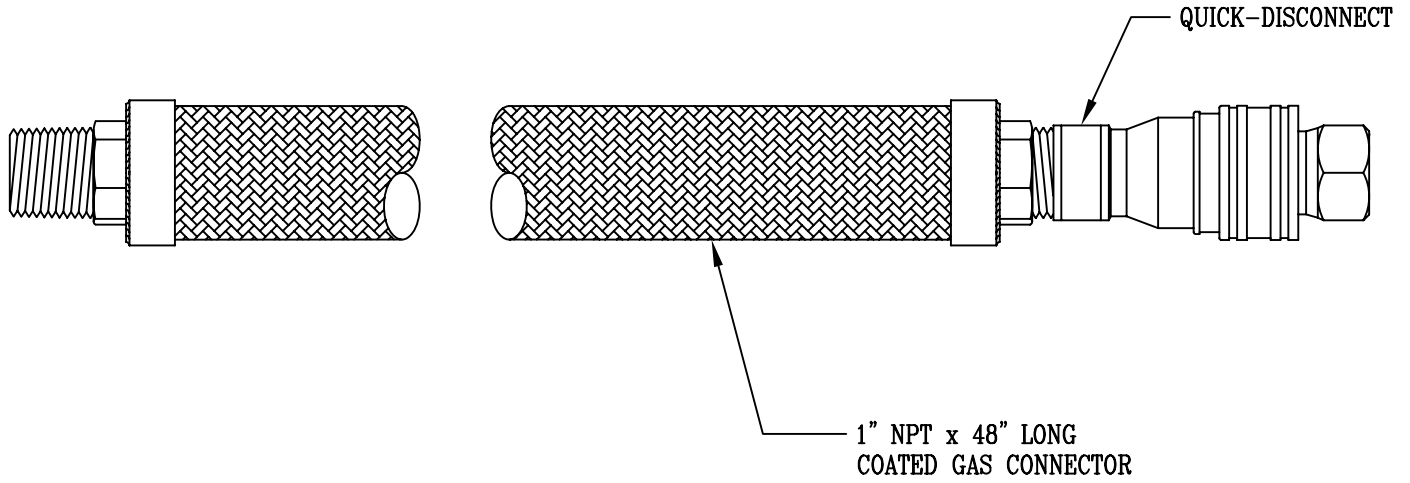

RESTRAINING CABLE KIT
INCLUDING ALL NECESSARY
HARDWARE (AG-RC)

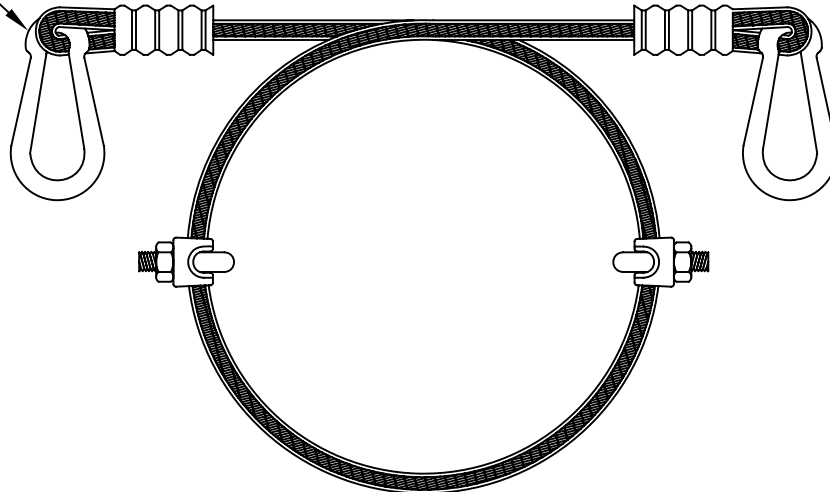

Product Description:
1" NPT x 48" LONG GAS HOSE w/ QUICK-DISCONNECT,
RESTRAINING CABLE KIT

Drawn:

KJG

Checked

DHL

Scale:

NTS

Approved

JHB

Date:

01/18/10



T&S BRASS AND BRONZE WORKS, INC.
 2 Saddleback Cove / P.O. Box 1088
 Travelers Rest, SC 29690

Model No.
HG-4-PS Series

Item No.

Travelers Rest, SC: 800-476-4103 • Simi Valley, CA: 800-423-0150 • Fax: 864-834-3518 • www.tsbrass.com

This Space for Architect/Engineer Approval

Job Name _____ Date _____

Model Specified _____ Quantity _____

Customer/Wholesaler _____

Contractor _____

Architect/Engineer _____

SAFE-T-LINK



Coated Gas Connector
 w/ NPT Male Ends & (1)
 2-Piece Quick Disconnect

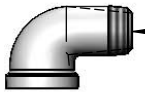

(1) Street El

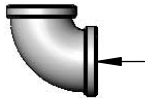

(1) 90° Elbow

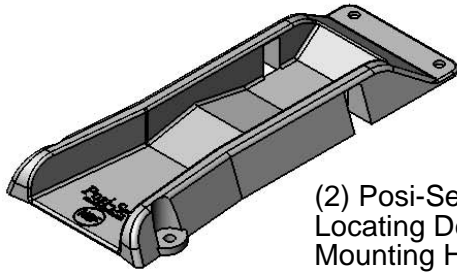

(2) Posi-Set Appliance
 Locating Devices w/
 Mounting Hardware

"L" = Length	1/2" NPT
36"	HG-4C-36-PS
48"	HG-4C-48-PS

"L" = Length	3/4" NPT
24"	HG-4D-24-PS
36"	HG-4D-36-PS
48"	HG-4D-48-PS
60"	HG-4D-60-PS

"L" = Length	1" NPT
48"	HG-4E-48-PS

HG-4-PS Series Product Configurator: HG - - PS

Ex: HG - 4 - PS

Gas Hose, 3/4" NPT Male Ends, 36" Length, (1) 2-Piece Quick Disconnect,
 (1) Street El, (1) 90° Elbow & (2) Posi-Set Appliance Locating Devices

Product Specifications:

Safe-T-Link Gas Appliance Connector:

Coated Hose w/ NPT Male Ends, 2-Piece Quick Disconnect, Street El,
 90° Elbow & Posi-Set Appliance Locating Devices

Drawn:

DHL

Checked:

DMH

Approved:

JHB

Scale:

NTS

Date:

09/27/12