



Technical Data

SURFACE MOUNTED ROLL-PAPER-TOWEL DISPENSER

B-72860



Patented

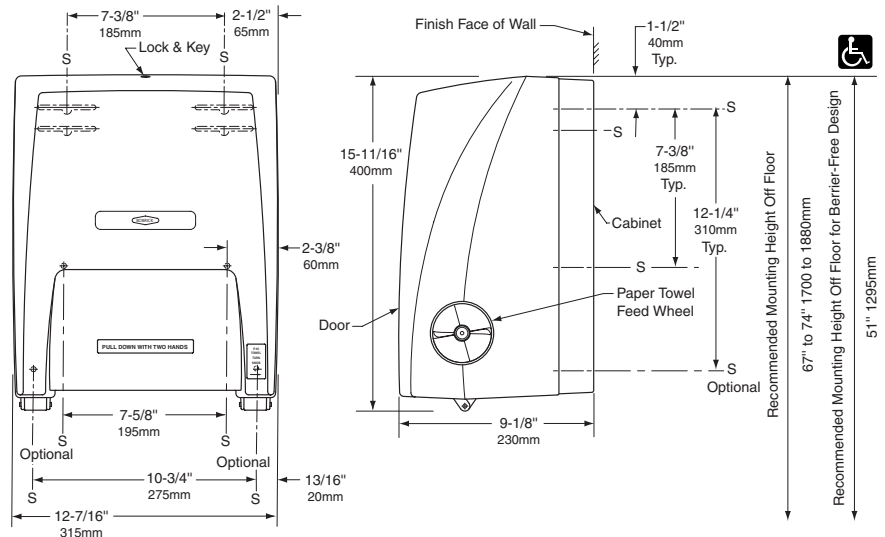

MATERIALS:

Door and Housing — Durable, high-impact resin materials. Door is translucent dark grey with high-gloss finish on exposed surfaces and is secured to light grey Housing with stainless steel hinge pins at bottom and keyed lock at top. Door may be opened with removable or permanent keys provided. Additional “permanent” snap-in key supplied for use in non-vandal-prone installations.

Roll-Paper-Towel Mechanism — Durable, high-impact resin materials. Accepts standard-core rolls up to 8" (205mm) wide, 8" (205mm) diameter. Dispenses one 12" (300mm) length of towel per pull. Accommodates up to 3-1/2" (90mm) diameter stub roll with automatic transfer to full roll.

OPERATION:

Touch-Free pull towel dispensing mechanism dispenses one 12" (300mm) length of towel per pull and operates smoothly and quietly. User only touches the paper. Exterior paper towel feed wheel available for use when filling dispenser and for user to advance paper should it become necessary to feed paper through dispenser. Automatic transfer dispenses stub roll before new roll is dispensed. When stub roll is depleted, advancement of paper towel feed wheel allows the main roll to start dispensing without the need to open the dispenser. Dispenser accommodates up to 8" (205mm) wide, 8" (205mm) diameter, non-perforated paper towel rolls and dispenses with less than 5 pounds of force (22.2N) to comply with barrier-free accessibility guidelines (including ADAAG in U.S.A.).

INSTALLATION:

Mount unit on wall with four sheet-metal screws, furnished by manufacturer, at points indicated by an S. Optional mounting screw locations available, at installer's discretion. Mounting template available on exterior of carton end. For plaster or drywall construction, provide concealed backing to comply with local building codes, then secure unit with sheet-metal screws. For other wall surfaces, use wall anchors, furnished by manufacturer, for use with sheet metal screws, or provide 1/8" (3mm) toggle bolts or expansion shields (not furnished) for use with machine screws.

SPECIFICATION:

Surface-mounted roll-paper-towel dispenser shall have durable, high-impact, dark translucent grey resin door with high-gloss finish on exposed surfaces and durable, high-impact, light grey resin housing with matte finish. Door shall be secured to housing with two stainless steel hinge pins and keyed lock. Door shall have lock which is opened with removable or permanent key. Towel mechanism accommodates up to 8" (205mm) wide, 8" (205mm) diameter, non-perforated paper towel rolls. Touch-Free pull towel mechanism dispenses one 12" (300mm) length of towel per pull. User only touches the paper. Automatic transfer shall dispense stub roll up to 3-1/2" (90mm) diameter before new roll is dispensed. Equipped with paper towel feed wheel for use in filling the dispenser, for user to advance paper should it become necessary to feed paper through dispenser. Paper towels are dispensed with pull force of less than 5 pounds (22.2N) to comply with barrier-free accessibility guidelines (including ADAAG in U.S.A.).

Surface-Mounted Roll-Paper-Towel Dispenser shall be Model B-72860 of Bobrick Washroom Equipment, Inc., Clifton Park, New York; Jackson, Tennessee; Los Angeles, California; Bobrick Washroom Equipment Company, Scarborough, Ontario; Bobrick Washroom Equipment Pty. Ltd., Australia; and Bobrick Washroom Equipment Limited, United Kingdom.