

CODE NUMBER

3324242

DESCRIPTION

8" Trim Plate, Solar Power Supply, Integrated Side Mixer, Polished Chrome Finish, 1.5 gpm, Aerated Spray, Infrared Sensor, BASYS® Solar-Powered Deck-Mounted High Body Faucet.

DETAILS

- Flow Rate: 1.5 gpm (6 Lpm) (1.5GPM)
- Spray Type: Aerated (AER)
- Sensor Type: Infrared (IR)
- Mounting Type: Single Hole
- Trim Plate: 8" (203mm) (8)
- Power Supply: Solar (SOL)
- Temperature Mixer: Integrated Side Mixer (ISM)
- Finish: Polished Chrome (CP)
- Factory Default Timeout: 60s
- Factory Default GPC: 0.75

FEATURES

Commercial Grade, ADA Compliant, Electronic, Sensor-Activated, Die-CastMetal Hand Washing Faucet with the following features:

- One tool service
- All wetted components to be stainless steel, engineered thermoplastic, EPDM, and copper or copper alloy
- Solenoid housed in removable carrier that includes supply strainer
- Integral water supply shut off
- Supply strainer serviceable from above deck
- Vandal resistant spray insert, key housed inside faucet body
- All electronics sealed to IP-112
- Gold plated electrical contacts
- Above deck individual diagnostic indicators for battery life, solenoid condition, and power up mode
- Flexible, high pressure supply hoses, 3/8" compression connections
- Bi-stable magnetic solenoid
- Four (4) "AA" alkaline batteries
- Double infrared sensors with automatic setting feature Includes all mounting hardware
- Line purge mode, eliminates stagnant water
- Adjustable time-outs

ELECTRICAL SPECIFICATIONS

- Battery Life: 3 years
- Self-Adjustment Range: 2"-14" (51-356mm)
- Sensor Range: 4"-5" (102-127mm)

VIDEOS

- ▶ BASYS® Faucet Installation and Features

DOWNLOADS

- [EFX 1Xx/2Xx Installation Instructions](#)

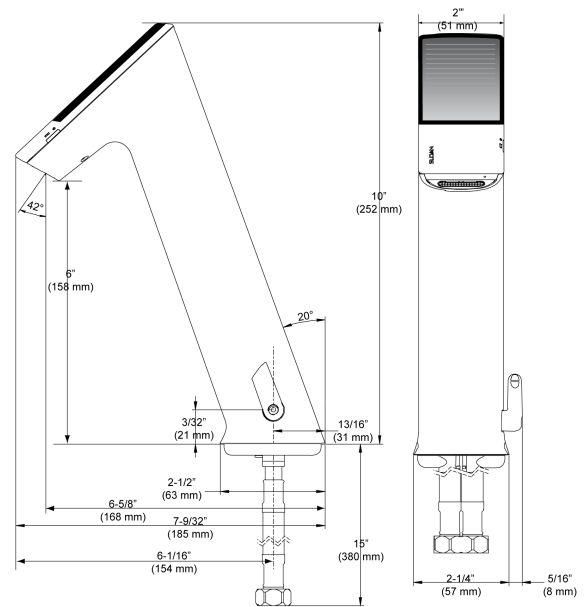

COMPLIANCES & CERTIFICATIONS



(ADA Compliant, UL Certified, CEC Compliant, cUPC Low Lead Compliant)

RECOMMENDED SPECIFICATION

Sloan BASYS model no. EFX-177.____.____ double infrared sensor- activated electronic handwashing faucet with battery back-up and line purge mode for pre-tempered or hot/cold water supplies. Product to have double infrared sensors with automatic setting feature. Solenoid valve housed in removable carrier that closes water supply upon removal eliminating need to access control stops. Solenoid carrier includes strainer for easy above-deck service. Optional thermostatic mixer complies

- [EFX 1Xx/2Xx \(SP\) Installation Instructions](#)
- [EFX 1Xx/2Xx Caddy Replacement Installation Instructions](#)
- [IR FAQs Repair and Maintenance Guide](#)
- [IR FAQs SP Repair and Maintenance Guide](#)
- [EFX-1XX Repair and Maintenance Guide](#)
- [Trim Plates Repair and Maintenance Guide](#)
- [Additional Downloads](#)

with ASSE 1070 requirements.

NOTES

All information contained within this document subject to change without notice.

Looking for other variations of the EFX-177 product? [View the general spec sheet with all options.](#)

[Find a matching soap dispenser](#) for this faucet.

[Find a compatible sink](#) for this faucet.

WARRANTY

3 Year

ROUGH-IN

EFX-177.00X.0X0X Faucet
with Single Line Water Supply

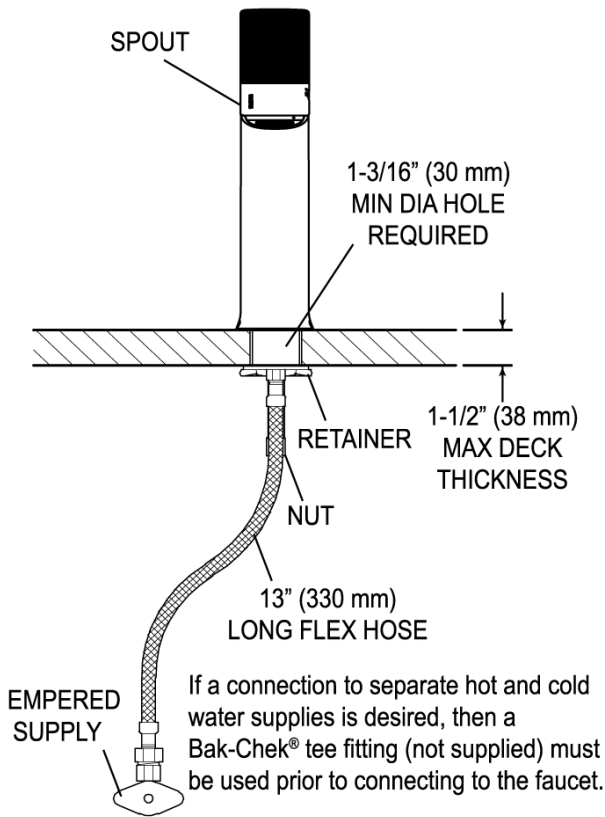

EFX-177.50X.0X0X Faucet
with Hot & Cold Water Supply

