



Limited One Year Warranty  
T&S warrants to the original purchaser (other than for purposes of resale) that such product is free from defects in material and workmanship for a period of one (1) year from the date of purchase. During this one-year warranty period, if the product is found to be defective, T&S shall, at its options, repair and/or replace it. To obtain warranty service, products must be returned to...

T&S Brass and Bronze Works, Inc.  
Attn: Warranty Repair Department  
2 Saddleback Cove  
Travelers Rest, SC 29690

Shipping, freight, insurance, and other transportation charges of the product to T&S and the return of repaired or replaced product to the purchaser are the responsibility of the purchaser. Repair and/or replacement shall be made within a reasonable time after receipt by T&S of the returned product. This warranty does not cover items which have received secondary finishing or have been altered or modified after purchase, or for defects caused by physical abuse to or misuse of the product, or shipment of the products.

Any express warranty not provided herein, and any remedy for Breach of Contract which might arise, is hereby excluded and disclaimed. Any implied warranties of merchantability or fitness for a particular purpose are limited to one year in duration. Under no circumstances shall T&S be liable for loss of use or any special consequential costs, expenses or damages.

Some states do not allow limitations on how long and implied warranty lasts or the exclusion or limitation of incidental or consequential damages, so the above limitations or exclusions may not apply to you. Specific rights under this warranty and other rights vary from state to state.

P/N: 098-012448-45 Rev.0  
Date: 990714  
Drawn: CW  
Checked: MAB 11-12-99  
Approved: MVW 11-13-99

# Installation and Maintenance Instructions



## FAUCET WITH NOZZLE AND SPRAY HOSE ASSEMBLY B-0177

**Deutsch: Installations- und  
Wartungsanleitungen**

**Español: la Instalación y las  
Instrucciones de  
Mantenimiento**

**Français: les Instructions  
d'Installation et  
d'Entretien**

# Exploded View

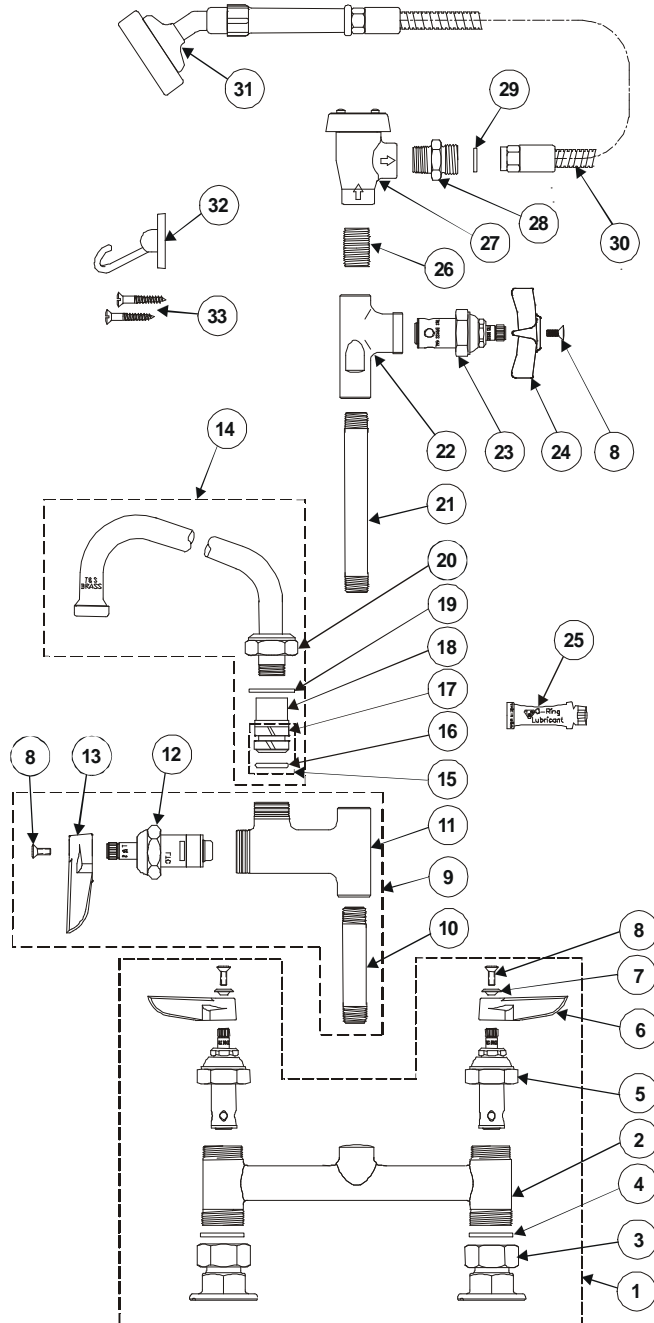

\* Some items are listed for instructional purposes and may not be sold as separate parts.

# Part Number Guide

## ***Faucet Assembly***

1	Asm, Faucet (Rigid)	002829-40
2	Faucet Body (Rigid)	*
3	Asm, Coupling Flange	002893-40
4	Washer	001019-45
5	Asm, Cartridge	
	LH, w/Spring Checks	002711-40
	RH, w/Spring Checks	002712-40
6	Handle, Lever - Hot	001637-45
	Handle, Lever - Cold	001636-45
7	Index, Button	
	Hot (Red)	001661-45
	Cold (Blue)	001660-45
8	Screw, Handle	000922-45
21	Nipple, 3/8" X 4"	*
22	Valve Body	*
23	Asm, Cartridge (Cold)	005959-40
24	Handle, 4-Arm	002521-45
25	Grease Tube	*
26	Nipple	002535-25
27	Asm, Vacuum Breaker 3/8"	B-0968
28	Adapter, 3/8" MA	000545-25
29	Washer #27	010476-45
30	Asm, Flex S/S Hose	B-0080-H
31	Asm, Spray Head	005969-40
32	Asm, Wall Hook	B-0104-D
33	Screws, Wall Mount	000915-45

## ***Add-On Faucet Assembly***

9	Asm, Add-on Faucet	
	B-0155, B-0156, B-0157	005964-40
10	Nipple, 3/8" X 3"	000358-40
11	Faucet Body	*
12	Asm, Cartridge, Quarter Turn	007947-40
13	Handle, Lever (Blank)	001638-45
8	Screw, Handle	000922-45

## Part Number Guide - con't

### **Nozzle Assembly**

14	Asm, Nozzle Swing	
	Nozzle, 6"	059X
	Nozzle, 12"	062X
	Nozzle, 18"	065X
15	Repair Kit***	011643-45
16	"O"-Ring	*
17	Sleeve, Swivel	*
18	Swivel Piece	*
19	Washer, Swivel Piece	*
20	Nut, Swivel	*

\*\*\*Repair kit includes items #16 and #17.

# General Instructions

## Nozzle Installation:

*Note: Nozzles should be installed first. See diagram below:*

### If installing to an existing rigid pre-rinse unit or base faucet

1. Shut off water supply and drain lines. Remove no.21 from no.2. Apply Teflon tape or pipe joint compound to threaded ends of no.10.
2. Place no.10 into no.2 and tighten firmly by hand.

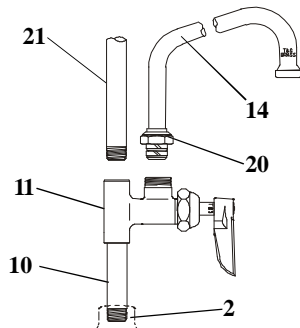

### To Install Swing Nozzle:

1. Insert no.14 into no.11 and rotate to desired position at sink.

Note: See Repair Kit 011643-45 for replacement of no.16 and no.17.

2. Tighten no.20 firmly with a wrench.

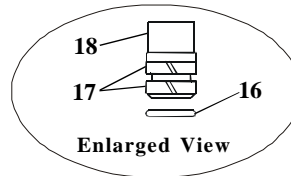

## Faucet Installation:

1. Drill (2) two holes, approximately 1-1/4" diameter in countertop with 8" centers, where you are installing no.2.

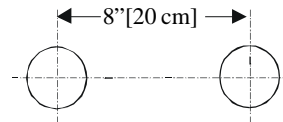

2. Apply Teflon tape or pipe joint compound to water supply lines.
3. Connect no.2 to water supply lines by screwing no.3 (with eccentric centers) onto nipple (supplied by others) and tightening no.3 against countertop. (Nut under countertop to be supplied by others). Trim supply lines if necessary.

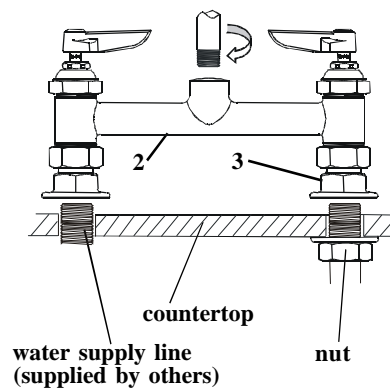

# General Instructions

## Installation of Control Valve:

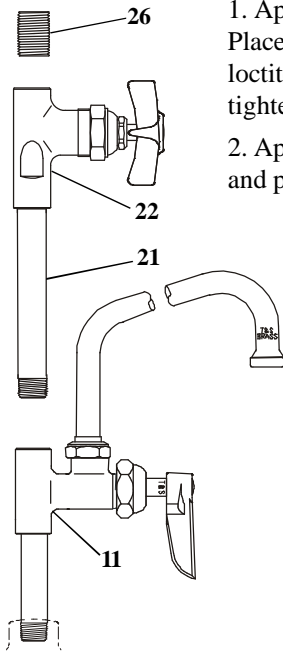

1. Apply Teflon tape on threaded ends of no.21. Place no.21 into no.22, tighten by hand. Apply loctite on no.26, insert between no.22 and no.27, tighten no.27 with a wrench.
2. Apply Teflon tape or pipe joint compound to no.21 and place into no.11 and tighten by hand.

## Vacuum Breaker and Hose Installation:

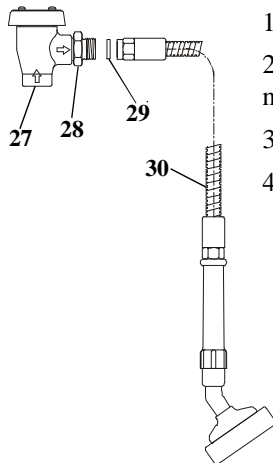

1. Apply Teflon tape on no.28 and place onto no.27.
2. Apply Teflon tape to threaded end of no.28. Attach no.30 to no.28 (make sure no.29 is in place).
3. Turn on water supply and check for leaks.
4. Install no.32 in a convient location.

# Instrucciones Generales

## Instalación de la boquilla:

*Nota: Las boquillas deben de ser instaladas primero. Vea el diagrama abajo:*

### Si esta instalando a una unidad existente rígida de pre-enjuage o a la base de una canilla

1. Cierre la fuente de agua y desagüe las tuberías. Remueva la parte No. 21 de la parte No. 2. Aplique cinta de Teflon o compuesto de coyuntura a los extremos con rosca de la parte No. 10.
2. Coloque la parte No. 10 dentro la parte No. 2 y apriete firmemente a mano.

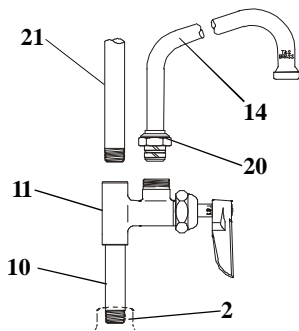

## Para instalar boquilla giradora:

1. Inserte la parte No. 14 dentro de la No. 11 y gire a una posición deseada en el lavatorio.

*Nota: Vea el estuche de reparos 011643-45 para remplazar las partes No. 16 y No. 17.*

2. Apriete firmemente la parte No. 20 con una llave.

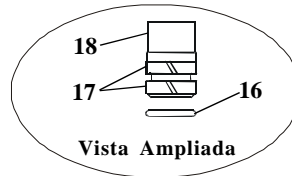

## Instalación de la Canilla:

1. Perfore (2) dos huecos, aproximadamente 1¼" de diámetro con centros de 8" en el mostrador, donde la parte No. 2 será instalada.

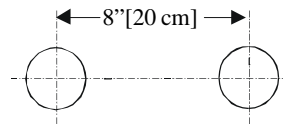

2. Aplique cinta de Teflon o compuesto de coyuntura a las líneas de surtido.

3. Conecte la parte No. 2 a las líneas de surtido atornillando la parte No. 3 (con centros excéntricos) al tubo (surtido por otros) y apriete la parte No. 3 contra el mostrador. (La tuerca debajo del mostrador será surtida por otros). Si es necesario recorte las líneas de surtido.

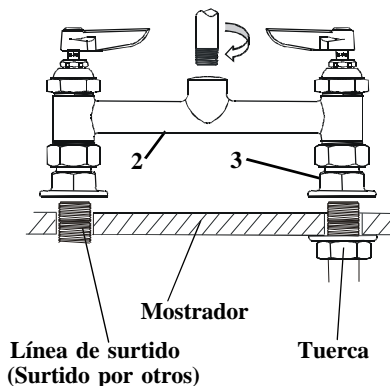

# Instrucciones Generales

## Instalación de la Válvula de Control:

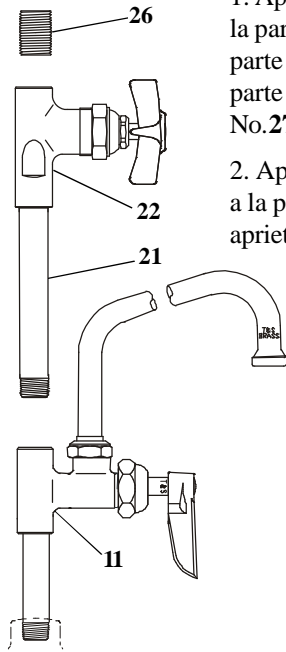

1. Aplique cinta de Teflon a los extremos con rosca de la parte No.21. Coloque la parte No.21 dentro de la parte No.22, y apriete a mano. Aplique Loctite en la parte No.26, y inserte dentro de las partes No.22 y No.27, Apriete la parte No.27 con una llave.

2. Aplique cinta de Teflon o compuesto de coyuntura a la parte No.21 colóquela dentro de la parte No.11 y apriete a mano.

## Instalación de la Manguera y Anti-sifón:

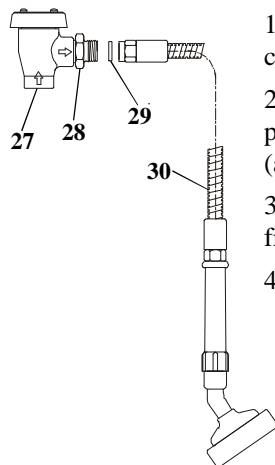

1. Aplique cinta de Teflon en la parte No.28 y colóquela dentro de la parte No.27.

2. Aplique cinta de Teflon al extremo con roscas de la parte No.28. Junte la parte No.30 a la parte No.28 (asegúrese que la parte No.29 este en su sitio).

3. Abra la fuente de agua e inspeccione por filtraciones.

4. Instale la parte No.32 en un sitio conveniente..



# Instructions Générales

## L'Installation De L'Ajutage:

*Noter: Les ajutages doivent être installés au début. Voir le diagramme ci-dessous:*

### Si vous installez à l'élément Pré-encasté existant ou le robinet de la base :

1. Fermer la réserve de l'eau et égoutter la tuyauterie. Enlever N° 21 de N° 2. Appliquer le ruban en Téflon ou le composé pour les tuyaux à l'extrémité de N° 10 avec les filets.
2. Resserrer N° 10 fermement par la main dans N° 2.

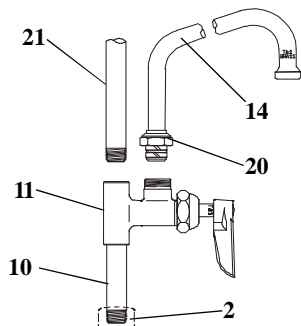

### Pour Installer L'Ajutage D'Entrain:

1. Insérer N° 14 dans N° 11 et tourner jusqu'à la position désirée de l'évier.

Noter: Voir la trousse à outils **011643-45** pour remplacer N° 16 et N° 17.

2. Resserrer N° 20 fermement avec une clef anglaise.

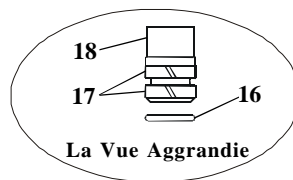

## L'Installation Du Robinet :

1. Percer (2) deux trous, avec un diamètre de 1-1/4" dans le comptoir de l'évier avec les centres de 8", où vous allez installer N° 2.

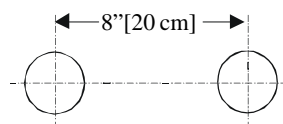

2. Appliquer le ruban en Téflon ou le composé pour les tuyaux aux filets des tuyaux qui fournissent l'eau.

3. Brancher N° 2 aux tuyaux qui fournissent l'eau en branchant N° 3 (avec les centres excentriques) sur le raccord (fourni par les autres) et resserrer N° 3 contre le comptoir. (L'écrou au-dessous du comptoir fourni par les autres). Couper un peu les tuyaux qui fournissent l'eau si nécessaire.

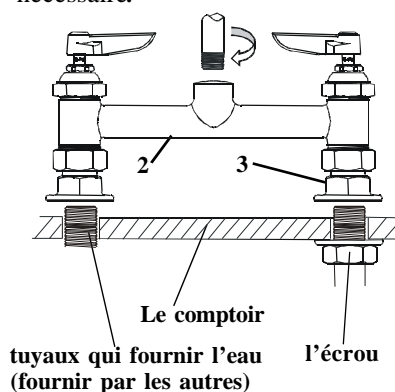

# Instructions Générales

## Installation de soupape de commande:

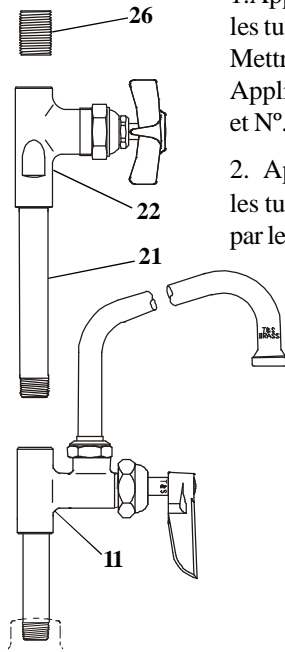

1. Appliquer le ruban en Téflon ou le composé pour les tuyaux à l'extrémité de N° .21 avec les filets. Mettre N° .21 dans N° .22 et resserrer par le main . Appliquer le "Loctite" sur N° .26, insérer entre N° .22 et N° .27, resserrer N° .27 avec une clef anglaise.
2. Appliquer le ruban en Téflon ou le composé pour les tuyaux à N° .21 et mettre dans N° .11 et resserrer par le main.

## L'Installation De Briseur De Vide et Le Tuyau:

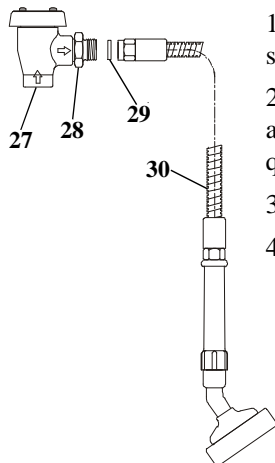

1. Appliquer le ruban en Téflon sur N° .28 et mettre sur N° .27.
2. Appliquer le ruban en Téflon à l'extrémité de N° .28 avec les filets. Attacher N° .30 à N° .28. (Soyez certain que N° .29 être à sa place).
3. Recommencer l'eau et vérifier s'il y a des fuites.
4. Installer N° .32 dans un emplacement convenable.

# Allgemeine Anleitungen

## Installation der Schwenkdüse:

*Hinweis: Schwenkdüsen sollten als erstes installiert werden. Sehen Sie dazu das Diagramm unten:*

## Falls an einer bereits vorhandenen Vorspüleinheit oder einem einfachen Wasserhahn installiert wird

1. Wasserzufuhr abdrehen und Rohre leerlaufen lassen. Entfernen Sie Nr. 21 von Nr. 2. Tragen Sie Teflonband oder Rohrkitt zu den Gewindeenden der Nr. 10 auf.
2. Setzen Sie Nr. 10 in Nr. 2 und ziehen Sie es fest von Hand an.

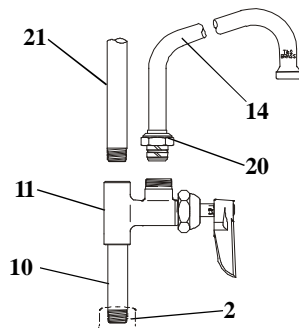

## Zur Installation des Schwenkarmes:

1. Führen Sie Nr. 14 in Nr. 11 ein und drehen Sie dieses bis die gewünschte Position am Becken erreicht ist.

Hinweis: Verweisen Sie zum Reparaturkit **011643-45** für Ersatzanweisungen der Nr. 16 und Nr. 17.

2. Ziehen Sie Nr. 20 mit Hilfe eines Schraubenschlüssels fest an.



## Installation des Wasserhahnes:

1. Bohren Sie (2) zwei Löcher ungefähr 3 cm (1 1/4") mit einem Abstand von 20 cm (8") von Lochmitte zu Lochmitte in die Arbeitsplatte in der Sie Nr. 2 installieren.

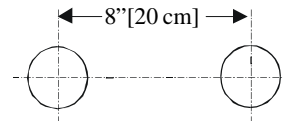

2. Tragen Sie Teflonband oder Rohrkitt auf die Wasserzufuhrleitungen auf.
3. Verbinden Sie Nr. 2 zu den Wasserzufuhrleitungen indem Sie Nr. 3 (mit versetzter Mitte) auf den Nippel (nicht in der Lieferung enthalten) schrauben und Nr. 3 gegen die Arbeitsplatte festziehen. (Die Mutter unter der Arbeitsplatte ist nicht in der Lieferung enthalten). Falls nötig Wasserzufuhrleitungen kürzen.

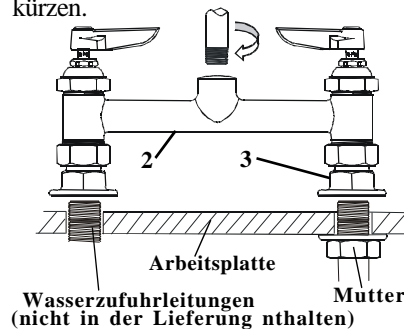

# Allgemeine Anleitungen

## Installation des Kontrollventils:

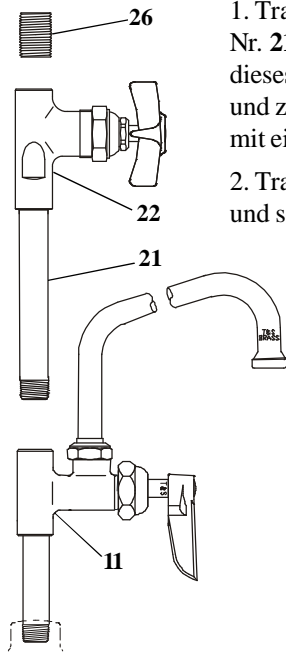

1. Tragen Sie Teflonband auf die Gewindeenden der Nr. 21 auf. Setzen Sie Nr. 21 in Nr. 22 und ziehen Sie dieses von Hand fest an. Loctite auf Nr. 26 auftragen und zwischen Nr. 22 und Nr. 27 einfügen, dann Nr. 27 mit einem Schraubenschlüssel fest anziehen.

2. Tragen Sie Teflonband oder Rohrkitt an Nr. 21 auf und setzen Sie es in Nr. 11, dann von Hand festziehen.

## Vakuumsicherungs- und Schlauchinstallation:

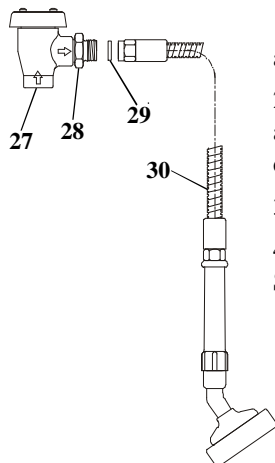

1. Teflonband auf Nr. 28 auftragen und zur Nr. 27 aufsetzen.

2. Tragen Sie Teflonband zum Gewindeende der Nr. 28 auf. Befestigen Sie Nr. 30 zur Nr. 28 (stellen Sie sicher, daß sich Nr. 29 in der richtigen Position befindet).

3. Wasserzufuhr andrehen und auf Dichtheit prüfen.

4. Installieren Sie Nr. 32 an einer günstig gelegenen Stelle.

**RELATED T&S BRASS PRODUCT LINE**



**B-0175**  
**Wall Mounted Faucet**  
**with 12" Swing Nozzle**  
**and Spray Unit**



**B-0176**  
**Deck Mounted Faucet**  
**with 12" Swing Nozzle**  
**and Spray Unit**

---

**T&S BRASS AND BRONZE WORKS, INC.**

A firm commitment to application-engineered plumbing products

2 Saddleback Cove, P.O. Box 1088,  
Travelers Rest, SC 29690

Phone: (864) 834-4102

Fax: (864) 834-3518

E-mail: [tsbrass@tsbrass.com](mailto:tsbrass@tsbrass.com)

T & S Brass-Europe

'De Veenhoeve'

Oude Nieuwveenseweg 84

2441 CW Nieuwveen

The Netherlands





**Limited One Year Warranty**

T&S warrants to the original purchaser (other than for purposes of resale) that such product is free from defects in material and workmanship for a period of one (1) year from the date of purchase. During this one-year warranty period, if the product is found to be defective, T&S shall, at its options, repair and/or replace it. To obtain warranty service, products must be returned to...

*T&S Brass and Bronze Works, Inc.  
Attn: Warranty Repair Department  
2 Saddleback Cove  
Travelers Rest, SC 29690*

Shipping, freight, insurance, and other transportation charges of the product to T&S and the return of repaired or replaced product to the purchaser are the responsibility of the purchaser. Repair and/or replacement shall be made within a reasonable time after receipt by T&S of the returned product. This warranty does not cover items which have received secondary finishing or have been altered or modified after purchase, or for defects caused by physical abuse to or misuse of the product, or shipment of the products.

Any express warranty not provided herein, and any remedy for Breach of Contract which might arise, is hereby excluded and disclaimed. Any implied warranties of merchantability or fitness for a particular purpose are limited to one year in duration. Under no circumstances shall T&S be liable for loss of use or any special consequential costs, expenses or damages.

Some states do not allow limitations on how long and implied warranty lasts or the exclusion or limitation of incidental or consequential damages, so the above limitations or exclusions may not apply to you. Specific rights under this warranty and other rights vary from state to state.

P/N: 098-011027-45 Rev.9  
Date: 03-22-12  
Drawn: TEH  
Checked: JRM 03-26-12  
Approved: JHB 03-27-12

# Installation and Maintenance Instructions



## **Pre-Rinse Spray Valve**

- |                 |                  |
|-----------------|------------------|
| <b>B-0107</b>   | <b>UK-0107</b>   |
| <b>B-0107-C</b> | <b>UK-10K</b>    |
| <b>B-0107-J</b> | <b>EB-0107</b>   |
| <b>B-10K</b>    | <b>EB-0107-C</b> |
| <b>B-10K-C</b>  | <b>EB-0107-J</b> |
| <b>B-10K-J</b>  | <b>EB-10K</b>    |
|                 | <b>EB-10K-C</b>  |
|                 | <b>EB-10K-J</b>  |

# Exploded View

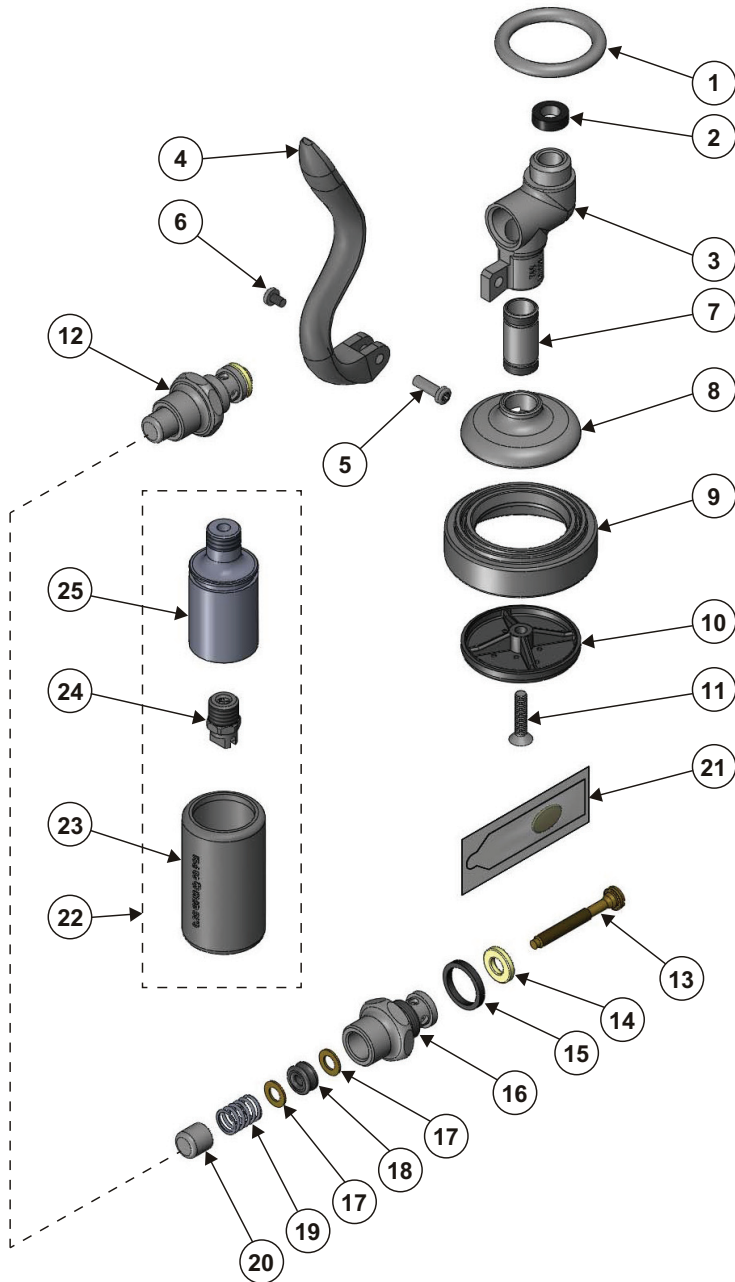

# Grey Part Number Guide

## PARTS KIT

### PARTS FOR ANY GREY T&S SPRAY VALVE

1,2,3	1	Ring, Hold Down	000907-45
	2	#27 Washer	010476-45
	3	Body, Spray Valve	000065-40
	4	Grey Handle	001120-45
	5	Nut, Handle	003198-45
	6	Screw, Handle	003199-45

### PARTS FOR ANY GREY BONNET ASSEMBLY

1,2,3	12	Bonnet Assembly	002856-40
	13	Stem	009306-20
1,2,3	14	Washer, Seat	012915-45
1,2,3	15	Washer, Bonnet Binding	001040-45
1,2,3	16	Bonnet	000608-25
	17	Washer, Bonnet Brass	000974-45
1,2,3	18	Stem, Packing	001100-45
1,2,3	19	Spring, Bonnet	000895-45
1,2,3	20	Push Button	000753-25
	21	Grease Pack	012665-45

### GREY SPRAY VALVES

<b>B-0107 (1.42 GPM)</b>			
1	7	Nipple	000694-40
	8	Cup, Spray	000019-40
	9	Ring, Sprayhead	007861-45
	10	1.42 GPM Sprayface	001121-45
1	11	Screw, Sprayface	000913-45
<b>B-0107-C (0.65 GPM)</b>			
2	22	Assembly, B-0107C Spray Nozzle	002662-40
	23	0.65 GPM Grey Shield (No Outline Around Lettering)	002659-45
	24	0.65 GPM Spray Nozzle (0.65 Stamped on Face)	N/A
<b>B-0107-J (1.07 GPM)</b>			
3	22	Assembly, B-0107-J Spray Nozzle	N/A
	23	1.07 GPM Grey Shield (Square Outline)	018292-45
	24	1.07 GPM Spray Nozzle (1.07 Stamped on Face)	N/A
	25	Nozzle Holder	N/A

#1 Parts included in B-10K

#2 Parts included in B-10K-C

#3 Parts included in B-10K-J



# Blue Part Number Guide

## PARTS KIT

### PARTS FOR ANY BLUE T&S SPRAY VALVE

4,5,6,7	1	Ring, Hold Down	000907-45
	2	#27 Washer	010476-45
	3	Body, Spray Valve	000065-40
	4	Blue Handle	011454-45
	5	Nut, Handle	003198-45
	6	Screw, Handle	003199-45

### PARTS FOR ANY BLUE BONNET ASSEMBLY

4,5,6,7	12	Bonnet Assembly	010594-40
	13	Stem	009306-20
	14	Washer, Seat	010563-45
	15	Washer, Bonnet Binding	010565-45
	16	Bonnet	000608-25
	17	Washer, Bonnet Brass	000974-45
	18	Quad Seal	014615-45
	19	Spring, Bonnet	000895-45
	20	Push Button	000753-25
	21	Grease Pack	010573-45

### BLUE SPRAY VALVES

<b>EB-0107 &amp; UK-0107 Only</b>			
4,7	7	Nipple	000694-40
	8	Cup, Spray	000019-40
	9	Ring, Sprayhead	011475-45
	11	Screw, Sprayface	000913-45
4	10	4-6 GPM Sprayface ( <b>No Wording on Face</b> )	011456-45
	10	1.42 GPM Sprayface ( <b>Flow Rate on Face</b> )	017288-45
5	22	Assembly, EB-0107C Spray Nozzle	N/A
	23	0.65 GPM Blue Shield ( <b>No Outline Around Lettering</b> )	011499-45
	24	0.65 GPM Spray Nozzle ( <b>0.65 Stamped on Face</b> )	N/A
	24	0.65 GPM Spray Nozzle ( <b>0.65 Stamped on Face</b> )	N/A
6	22	Assembly, EB-0107-J Spray Nozzle	N/A
	23	1.07 GPM Blue Shield ( <b>Square Outline</b> )	018293-45
	24	1.07 GPM Spray Nozzle ( <b>1.07 Stamped on Face</b> )	N/A
	24	1.07 GPM Spray Nozzle ( <b>1.07 Stamped on Face</b> )	N/A
	25	Nozzle Holder	N/A

#4 Parts included in EB-10K  
 #5 Parts included in EB-10K-C  
 #6 Parts included in EB-10K-J  
 #7 Parts included in UK-10K

# General Instructions

## To replace worn parts:

1. Shut off water supply and drain lines. For ease of disassembly and reassembly, the *handle grip* can be removed from no.3.
2. Unscrew no.5 and no.6 to remove no.4. Unscrew and remove no.16 from no.3.
3. Hold no.20 with pliers in one hand, and with screwdriver, carefully unscrew no.13 from no.16.

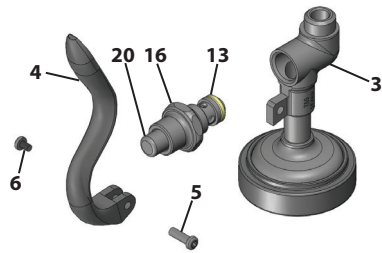

4. Apply no.21 over smooth portion of no.13. Replace no.14, no.15, no.17, no.18 & no.19 with new parts. Dab no.21 onto valve side of no.19 before replacing.

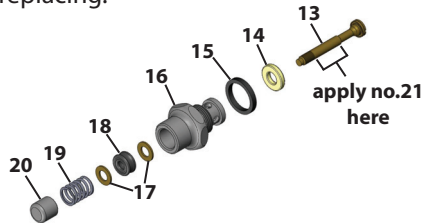

5. Reassemble no.16 by inserting no.13 through all parts. Hold no.20 with pliers, and carefully screw no.13 into no.20 until screw feels tight. Do not use excessive force.
6. Reinsert no.16 in no.3 and tighten securely.
7. Reassemble no.4, no.5 and no.6 on no.3.

8. **For EB-0107/UK-0107 & B-0107 ONLY:** To replace no.9, unscrew no.11 and disassemble. Make sure the groove side of no.9 fits over no.8, and no.10 rest on ridge side. See Figure A.

9. To replace no.2, unscrew handle grip from no.3 and replace with new no.2.

10. Reassemble; turn on water check for leaks.

Figure A

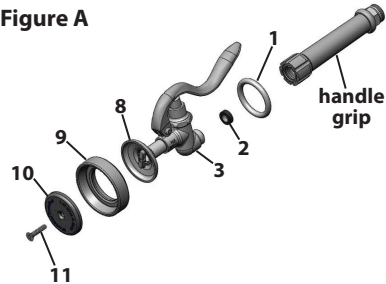

11. **For EB-0107-C, EB-0107-J, B-0107-C & B-0107-J ONLY:** To replace no.23, slide no.23 off no.25, and slide a new no.23 back onto no.25. No.23 will snap into groove on no.25. See Figure B.

\* **Verify the flow rate on no.23 matches spray tip inside no.25.**

Figure B

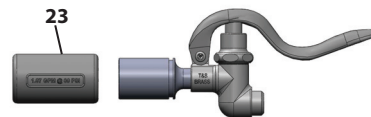

**Caution: Turn off water supply at base faucet when not in use.**

**RELATED T&S BRASS PRODUCT LINE**



**B-0108  
JeTSpray  
Spray Valve**



**B-0108-C  
JeTSpray  
Low Flow  
Spray Valve**

---

**T&S BRASS AND BRONZE WORKS, INC.**

A firm commitment to application-engineered plumbing products

2 Saddleback Cove, P.O. Box 1088,  
Travelers Rest, SC 29690

Phone: (864) 834-4102  
Fax: (864) 834-3518

E-mail: [tsbrass@tsbrass.com](mailto:tsbrass@tsbrass.com)

T & S Brass-Europe  
'De Veenhoeve'  
Oude Nieuwveenseweg 84  
2441 CW Nieuwveen

The Netherlands



**RELIABILITY BUILT IN™**