



T&S BRASS AND BRONZE WORKS, INC.
 2 Saddleback Cove / P.O. Box 1088
 Travelers Rest, SC 29690

Model No.
B-0576

Item No.

Travelers Rest, SC: 800-476-4103 • Simi Valley, CA: 800-423-0150 • Fax: 864-834-3518 • www.tsbrass.com



ADA Compliant

This Space for Architect/Engineer Approval

Job Name _____ Date _____

Model Specified _____ Quantity _____

Customer/Wholesaler _____

Contractor _____

Architect/Engineer _____

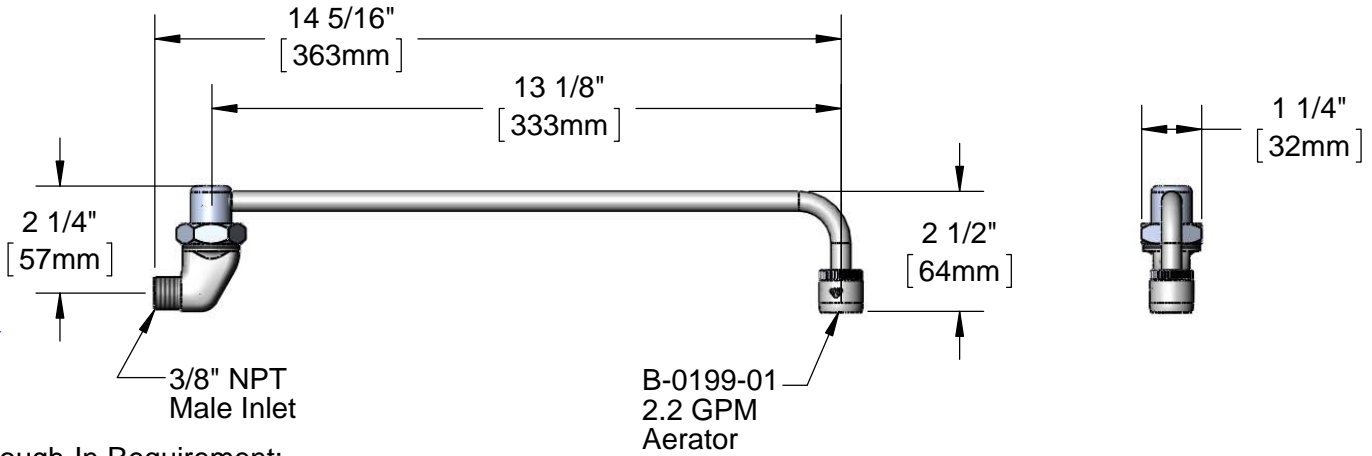
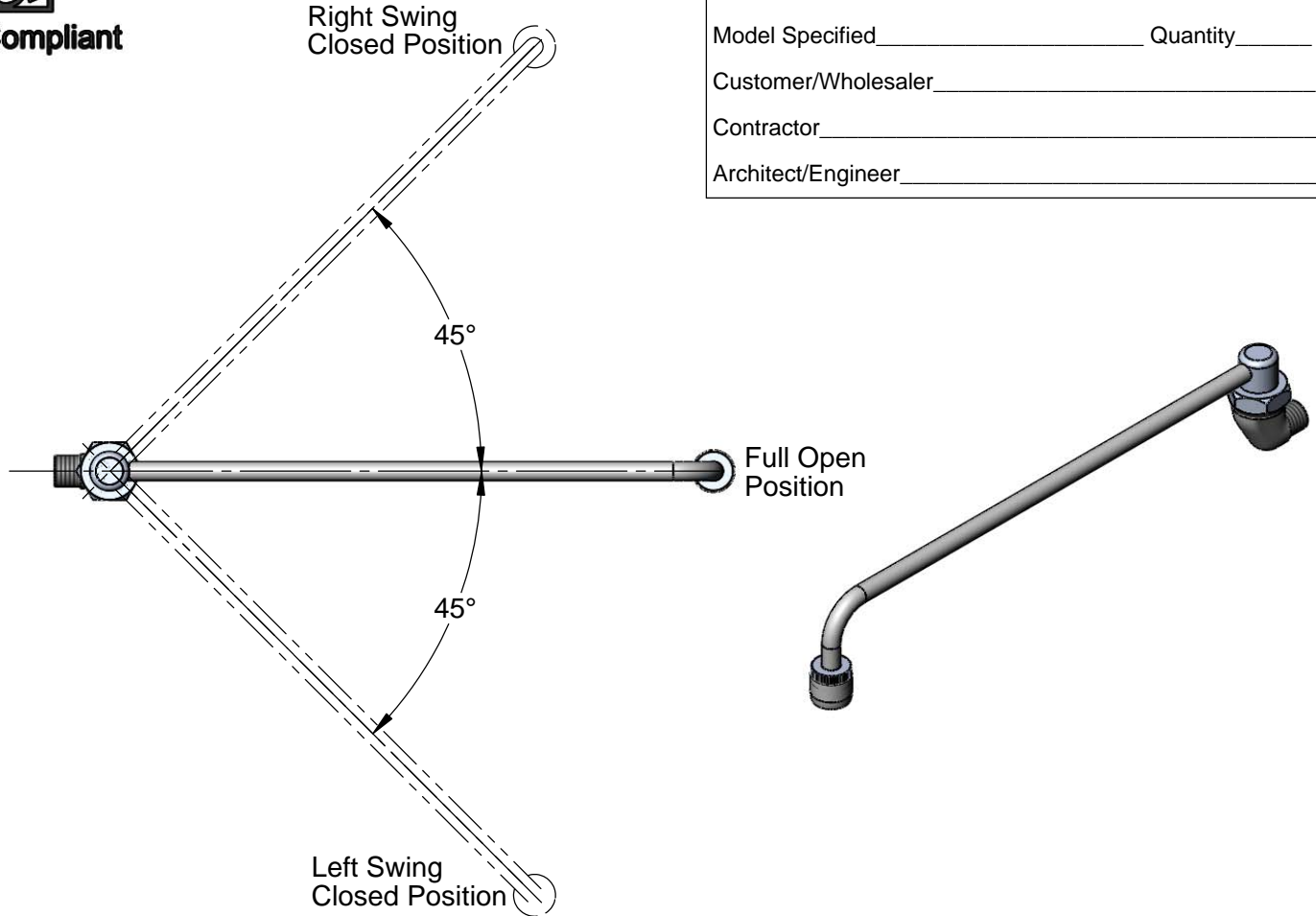

Rough-In Requirement:
 Ø 1" [25mm] Mounting Hole

Product Specifications:
 Range Faucet w/ Swing Nozzle, 2.2 GPM Aerator & 3/8" NPT Male Inlet

Product Compliance:
 ASME A112.18.1 / CSA B125.1
 NSF 61 - Section 9
 NSF 372 (Low Lead Content)
 ANSI A117.1 (ADA)



T&S BRASS AND BRONZE WORKS, INC.
 2 Saddleback Cove / P.O. Box 1088
 Travelers Rest, SC 29690

Model No.
B-0576

Item No.

Travelers Rest, SC: 800-476-4103 • Simi Valley, CA: 800-423-0150 • Fax: 864-834-3518 • www.tsbrass.com

ITEM NO.	SALES NO.	DESCRIPTION
1	001625-45	Spring
2	009267-45	O-Ring
3	001621-20	Dynamic Bearing
4	009268-45	O-Ring
5	001069-45	O-Ring
6	001626-40	Nozzle
7	001624-25	Adapter, 1/8" Female x Male Aerator
8	B-0199-01	2.2 GPM Aerator, 55/64-27 UN Female

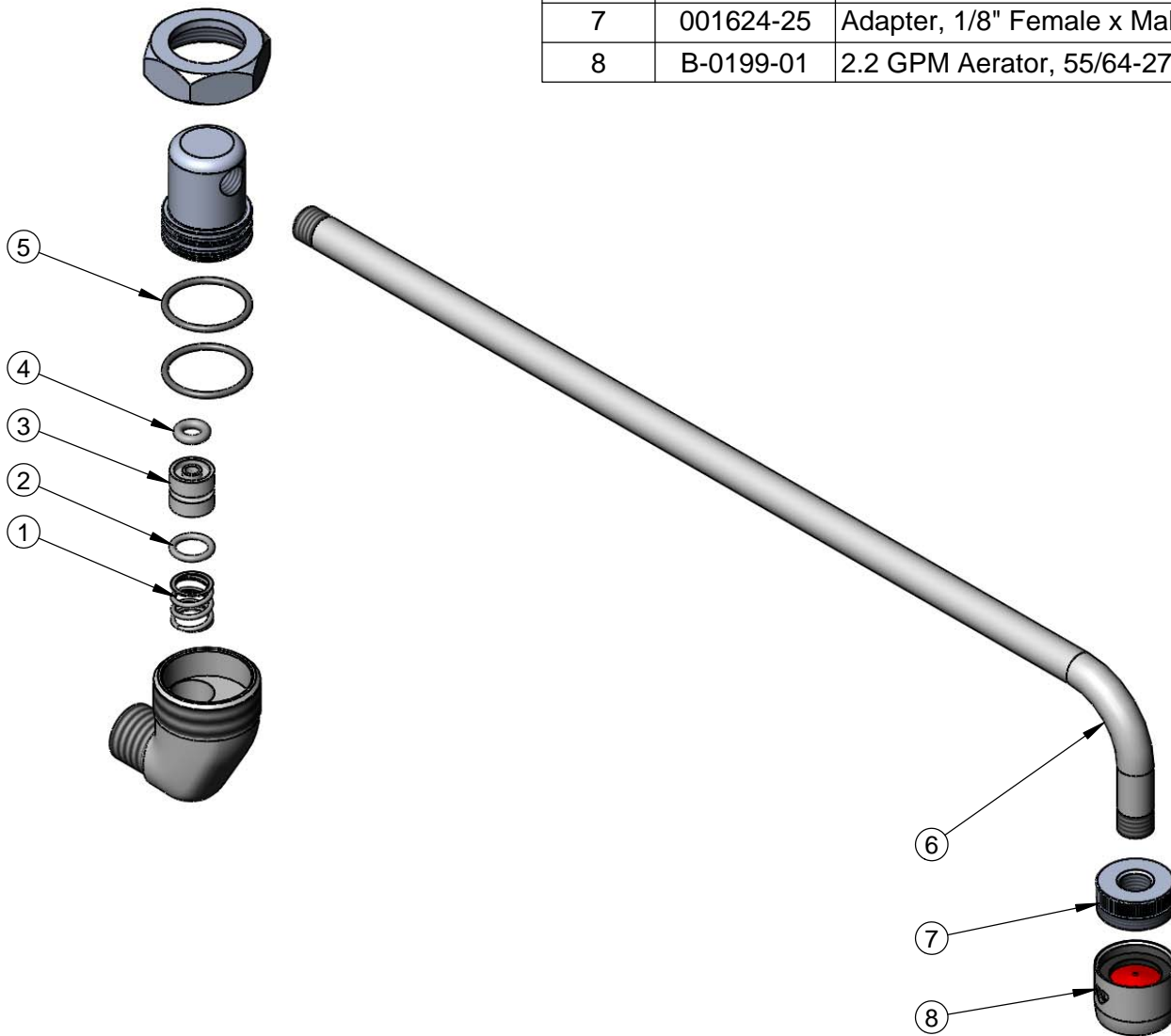

Product Specifications:
 Range Faucet w/ Swing Nozzle, 2.2 GPM Aerator & 3/8" NPT Male Inlet

Product Compliance:
 ASME A112.18.1 / CSA B125.1
 NSF 61 - Section 9
 NSF 372 (Low Lead Content)
 ANSI A117.1 (ADA)