



Limited One Year Warranty

T&S warrants to the original purchaser (other than for purposes of resale) that such product is free from defects in material and workmanship for a period of one (1) year from the date of purchase. During this one-year warranty period, if the product is found to be defective, T&S shall, at its options, repair and/or replace it. To obtain warranty service, products must be returned to...

T&S Brass and Bronze Works, Inc.
Attn: Warranty Repair Department
2 Saddleback Cove
Travelers Rest, SC 29690

Shipping, freight, insurance, and other transportation charges of the product to T&S and the return of repaired or replaced product to the purchaser are the responsibility of the purchaser. Repair and/or replacement shall be made within a reasonable time after receipt by T&S of the returned product. This warranty does not cover items which have received secondary finishing or have been altered or modified after purchase, or for defects caused by physical abuse to or misuse of the product, or shipment of the products.

Any express warranty not provided herein, and any remedy for Breach of Contract which might arise, is hereby excluded and disclaimed. Any implied warranties of merchantability or fitness for a particular purpose are limited to one year in duration. Under no circumstances shall T&S be liable for loss of use or any special consequential costs, expenses or damages.

Some states do not allow limitations on how long and implied warranty lasts or the exclusion or limitation of incidental or consequential damages, so the above limitations or exclusions may not apply to you. Specific rights under this warranty and other rights vary from state to state.

P/N: 098-012284-45
Date: 990316
Drawn: CW
Checked: MAB 4/6/99
Approved: MW 3/25/99

Installation and Maintenance Instructions



ADD-ON FAUCET B-0155 (also used for B-0156 and B-0157)

**Deutsch: Installations- und
Wartungsanleitungen**

**Español: la Instalación y las
Instrucciones de
Mantenimiento**

**Français: les Instructions
d'Installation et
d'Entretien**

Exploded View

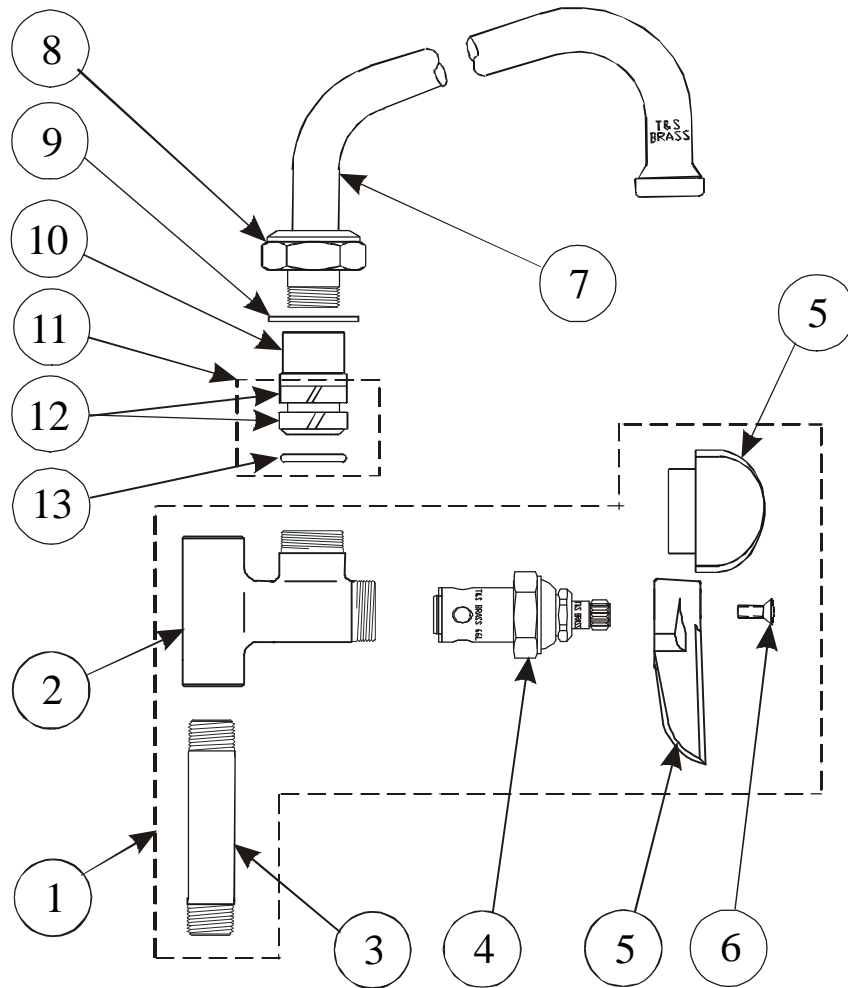

* Some items are listed for instructional purposes and may not be sold as separate parts.

Part Number Guide

Add-On Faucet

1	Asm, Base Faucet	
	B-0155, B-0156, B-0157	005964-40
2	Body, Faucet	*
3	Nipple, 3/8"x3"	000358-40
4	Asm, Qrtr-Turn Spindle	007947-40
5	Handle, Blank Lever	001638-45
	Handle, 3-Wing Brass	011782-40
6	Screw, Handle Lever	000922-45

Nozzle Assemblies

7	Asm, Swivel Nozzle - 6"	002877-40
	Asm, Swivel Nozzle - 12"	005952-40
	Asm, Swivel Nozzle - 18"	005955-40
8	Nut, Swivel	*
9	Washer, Swivel Piece	*
10	Swivel Piece	*
11	Repair Kit***	011643-45
12	Sleeve, Swivel	*
13	O-Ring	*

*** Kit includes items #12 & #13

General Instructions

Nozzle Installation:

Note: Nozzles should be installed first. See diagram below:

If installing to an existing rigid pre-rinse unit or base faucet

1. Shut off water supply and drain lines. Remove existing riser pipe from base faucet. Apply teflon tape or pipe joint compound to threaded ends of no.3.
2. Place no.3 into existing base faucet and tighten firmly by hand.

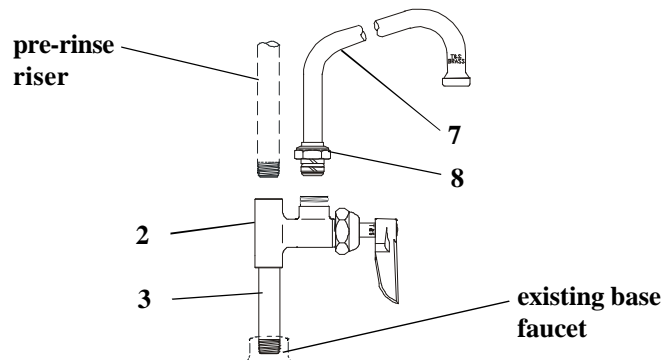

To install Swing Nozzle:

3. Insert no.7 into no.2 and rotate to desired position at sink.

Note: See Repair Kit **011643-45** for replacement of no.12 and no.13.

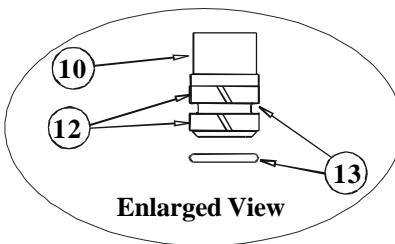

4. Tighten no.8 firmly with a wrench.
5. Apply teflon tape or pipe joint compound to existing pre-rinse riser pipe and place into no.2 and tighten by hand
6. Turn on water supply and check for leaks.

Instrucciones Generales

Instalación de la boquilla:

Nota: Las boquillas deben ser instaladas primero. Vea el diagrama de abajo:

Si esta instalando a una unidad existente de pre-enjuague rígida o a la base de canilla

1. Cierre la fuente de agua y desagüe las tuberías. Remuévala el tubo de extensión existente de la base de la canilla. Aplique cinta de Teflon o compuesto de coyuntura a las extremidades enroscadas de la parte No.3.

2. Coloque la parte No.3 en la base de la canilla existente y aprete a mano firmemente.

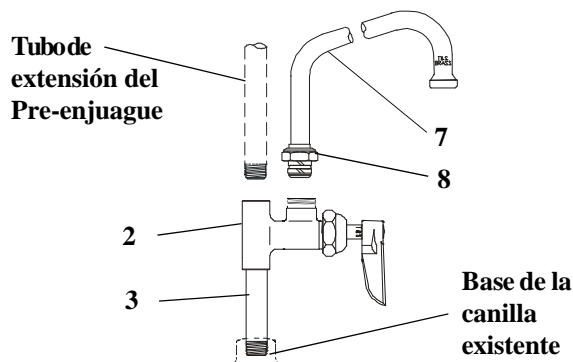

Para La Instalación De La Boquilla Giratoria:

3. Inserte la parte No.7 entre la parte No.2 y gire a una posición deseada en la sentina.

Nota: Para el reemplazo de las partes No.12 y No.13 refiérase al estuche de reparo 011643-45.

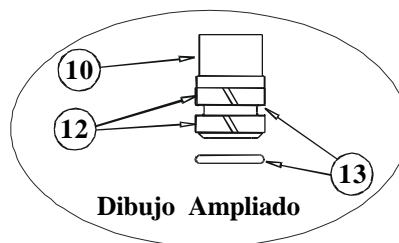

4. Apreté firmemente con una llave la parte No.8.

5. Aplique cinta de Teflon o compuesto de coyuntura al tubo de extensión existente de la unidad de pre-enjuague y coloquelo entre la parte No.2, aprete a mano.

6. Abra el surtido de agua e inspeccione por filtraciones.

Instructions Générales

L'Installation De L'Ajutage:

Noter: Les ajutages doivent être installés au début. Voir le diagramme ci-dessous.

Si vous installez un élément pré-rinçage rigide ou un robinet de la base.

1. Fermer la réserve de l'eau et égoutter la tuyauterie. Enlever le tuyau d'augmentation existant du robinet de la base. Appliquer le ruban en Téflon ou le composé pour les tuyaux à l'extrémité avec les filets de N°3.

2. Mettre N°3 dans le robinet de la base existante et resserrer fermement par le main.

le tuyau d'augmentation pré-rinçage

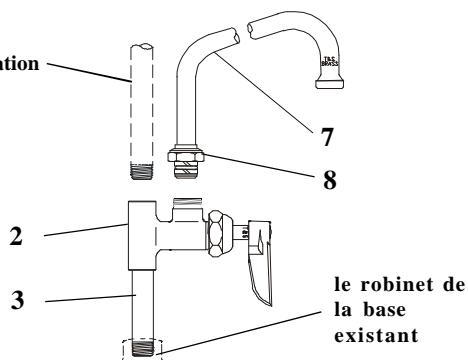

Pour installer l'ajutage pivotant:

3. Insérer N°7 dans N°2 et le tourner jusqu'à la position désirée sur l'évier.

Noter: Voir la trousse à outils 011643-45 pour remplacer N°12 et N°13.

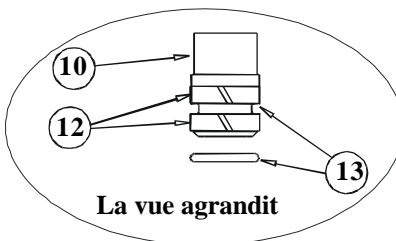

4. Resserrer N°8 fermement avec une clef anglaise.

5. Appliquer le ruban en Téflon ou le composé pour les tuyaux au tuyau d'augmentation pré-rinçage existant et mettre dans N°2 et resserrer par le main.

6. Recommencer l'eau et vérifier s'il y a des fuites.

Allgemeine Anleitungen

Schwenkarm-Installation:

Anmerkung: Die Schwenkarme sind als erstes zu installieren. Siehe Darstellung unten:

Wenn er auf eine bestehende starre Vorspüleinheit oder auf ein vorhandenes Unterteil installiert wird:

1. Wasserzufuhr abstellen und Wasserleitungen entleeren.
Bestehendes Steigleitungsrohr vom Unterteil entfernen. Teflonband oder Rohrkitt auf die Gewindeenden von Nr. 3 auftragen.

2. Nr. 3 in Hauptventil einfügen und mit der Hand festdrehen.

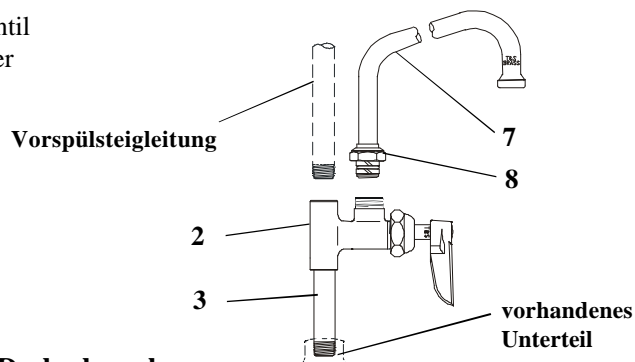

Installation des Drehschwenkarms:

3. Nr. 7 in Nr. 2 einfügen und in die gewünschte Stellung auf dem Spültisch drehen.

Anmerkung: Siehe Reparaturset 011643-45 für Ersatz von Nr. 12 und Nr. 13.

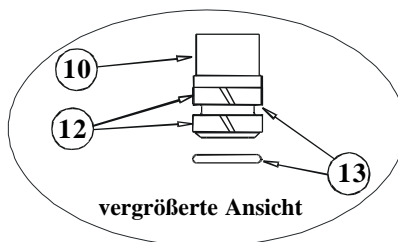

4. Nr. 8 fest mit einem Schraubenschlüssel anziehen.

5. Teflonband oder Rohrdichtungsmasse auf vorhandenes Vorspülsteigleitungsrohr auftragen, in Nr. 2 einsetzen und mit der Hand festdrehen.

6. Wasserzufuhr andrehen und auf Dichtigkeit prüfen.

T&S BRASS AND BRONZE WORKS, INC.

A firm commitment to application-engineered plumbing products

2 Saddleback Cove, P.O. Box 1088,
Travelers Rest, SC 29690

Phone: (864) 834-4102
Fax: (864) 834-3518

E-mail: tsbrass@tsbrass.com

T & S Brass-Europe
'De Veenhoeve'
Oude Nieuwveenseweg 84
2441 CW Nieuwveen

The Netherlands





T&S Brass and Bronze Works, Inc.
2 Saddleback Cove, P.O. Box 1088
Travelers Rest, SC 29690
TEL: (800) 476-4103
FAX: (800) 868-0084



B-0155 Add-on Faucet
(pre-retrofit).

How to Install a T&S Add-on Faucet on an Easy Install PRU.

B-0155
B-0156
B-0157



1A

Step 1A: Remove Riser from Base Faucet by unthreading Easy Install locking nut and pulling up until the riser “pops” out.

Step 1B: Using a 3/8” Allen Wrench, remove Easy Install Bushing & Locking Nut from riser.

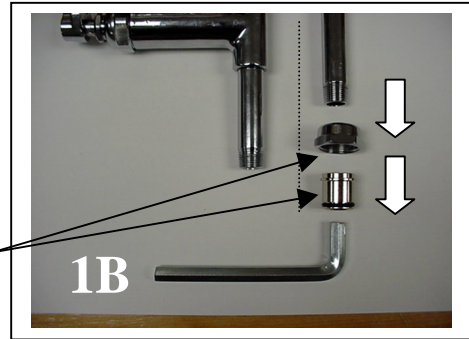

1B

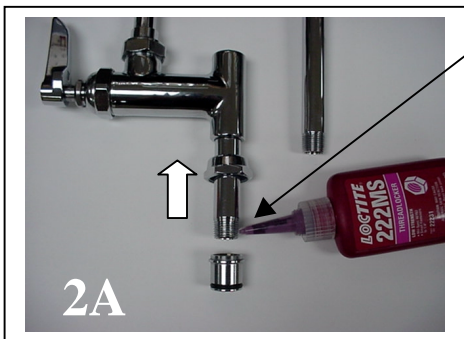

2A

Step 2A: Slide Easy Install Nut onto base of Add-on Faucet & Apply Loctite 222 (or other non-permanent thread lock compound) to Add-on faucet’s bottom threads.

Step 2B: Thread Easy Install bushing over base of Add-on faucet. Tighten with a 3/8” Allen wrench.

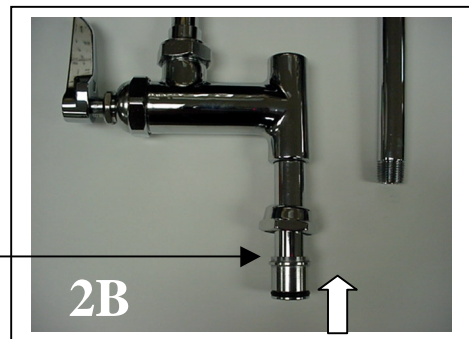

2B

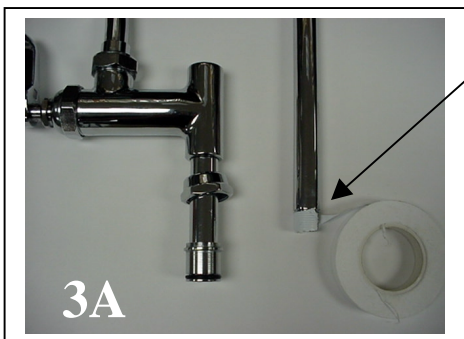

3A

Step 3A: After cleaning with mild soap and water, apply plumber’s tape or putty to base threads of riser.

Step 3B: Thread bottom of riser into top female section of Add-on Faucet. Tighten.

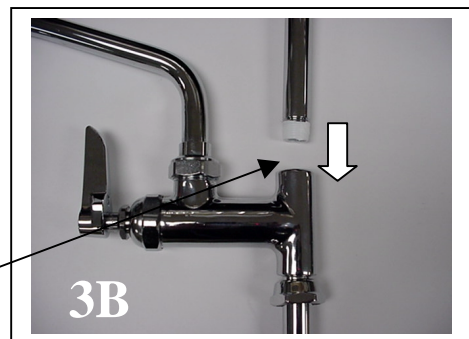

3B



4A

Step 4A: The Add-on Faucet & upper pre-rinse assembly are ready to be reconnected to the base faucet.

Step 4B: Press the bushing down into faucet body and tighten locking nut.

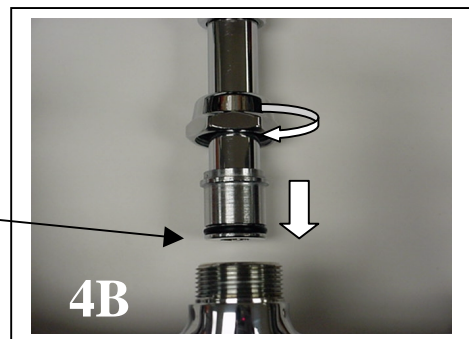

4B



T&S Brass and Bronze Works, Inc.
2 Saddleback Cove, P.O. Box 1088
Travelers Rest, SC 29690
TEL: (800) 476-4103
FAX: (800) 868-0084

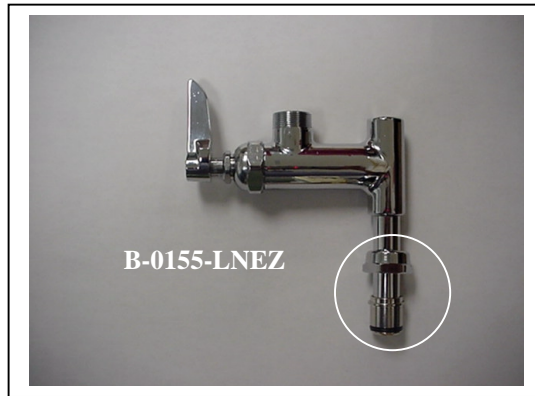

B-0155-LNEZ

How to Install a T&S Easy Install Add-on Faucet on an Easy Install PRU.

B-0155-LNEZ



1A

Step 1A: Loosen the Easy Install locking nut from the riser to base-faucet connection.

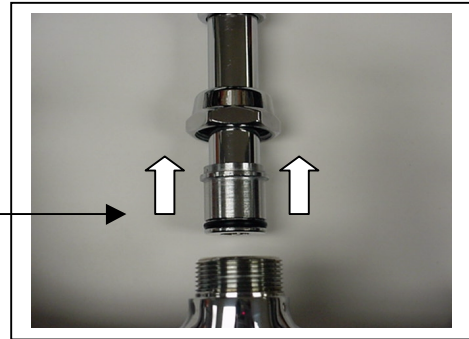

Step 1B: Remove the riser from the base faucet by pulling up on it.

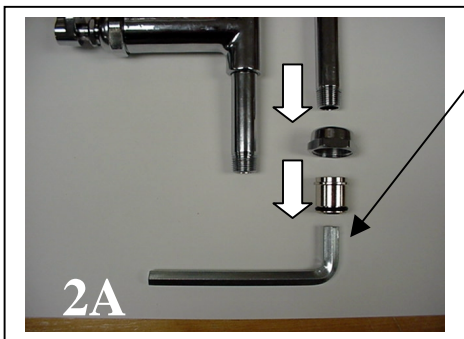

2A

Step 2A: Using a 3/8" Allen wrench, remove the bushing and locking nut from riser. (Either keep as spare parts or discard.)

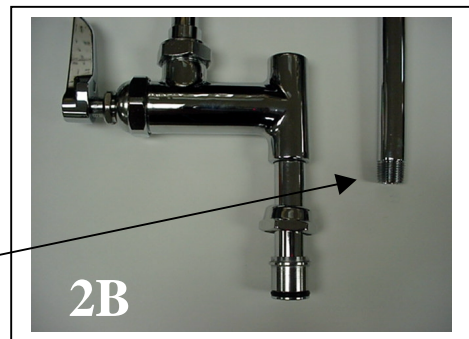

2B

Step 2B: Clean Loctite residue from riser threads with soap and water. Your riser is now almost ready to be connected to the add-on faucet.

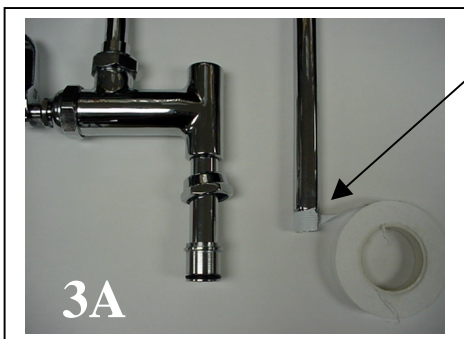

3A

Step 3A: Apply plumber's tape or putty to base threads of riser.

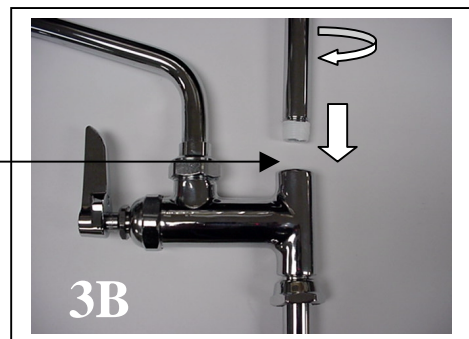

3B

Step 3B: Thread bottom of riser into top female section of Add-on Faucet. Tighten.



4A

Step 4A: The Add-on Faucet & upper pre-rinse assembly are ready to be reconnected to the base faucet.

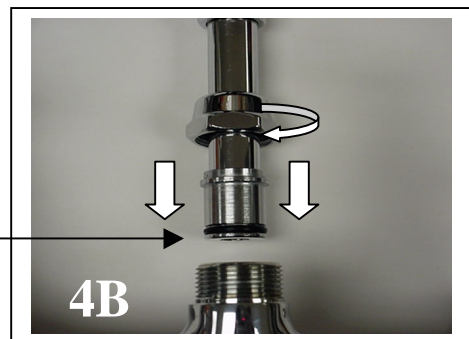

4B

Step 4B: Press the bushing down into faucet body and tighten locking nut.