



T&S BRASS AND BRONZE WORKS, INC.
 2 Saddleback Cove / P.O. Box 1088
 Travelers Rest, SC 29690

Model No.
EB-0107-C

Item No.

Travelers Rest, SC: 800-476-4103 • Simi Valley, CA: 800-423-0150 • Fax: 864-834-3518 • www.tsbrass.com



This Space for Architect/Engineer Approval

Job Name _____ Date _____

Model Specified _____ Quantity _____

Customer/Wholesaler _____

Contractor _____

Architect/Engineer _____

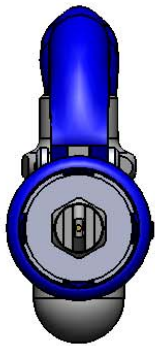
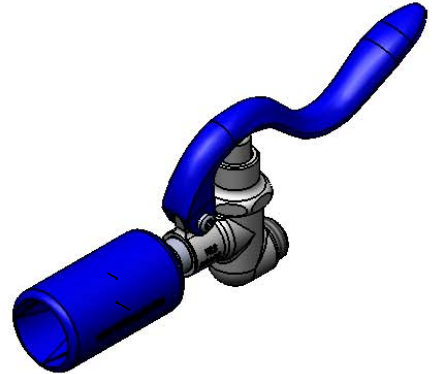
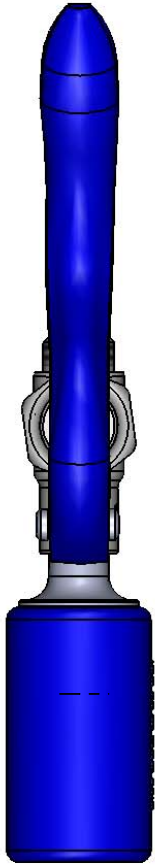

Hose Washer &
 Hold Down Ring
 (Included)

8 15/16"
 [227mm]

Ø 1 1/2"
 [38mm]

5 1/2"
 [139mm]

Self-Closing
 Cartridge

3/4"-14 UN
 Male Inlet

Flow Rate: 0.65 GPM (2.5 Lpm) @ 60 PSI
 Spray Force: 4.4 Ozf (125 Gramf)

Product Specifications:
 Blue Self-Closing Pre-Rinse Spray Valve w/ 0.65 GPM Spray Nozzle

Product Compliance:
 ASME A112.18.1 / CSA B125.1
 NSF 61 - Section 9
 NSF 372 (Low Lead Content)
 EPA Act 2005 (PRSV)
 EPA WaterSense (PRSV)



T&S BRASS AND BRONZE WORKS, INC.
 2 Saddleback Cove / P.O. Box 1088
 Travelers Rest, SC 29690

Model No.
EB-0107-C

Item No.

Travelers Rest, SC: 800-476-4103 • Simi Valley, CA: 800-423-0150 • Fax: 864-834-3518 • www.tsbrass.com

ITEM NO.	SALES NO.	DESCRIPTION
1	003199-45	Spray Valve Handle Screw
2	011454-45	Blue Spray Valve Handle
3	010594-40	Spray Valve Bonnet
4	003198-45	Spray Valve Handle Nut
5	010476-45	#27 Washer
6	000907-45	Spray Valve Hold Down Ring w/ Washer
7	011499-45	Blue Shield, Low Flow 0.65 GPM
8	003128-25	Low Flow Nozzle Holder

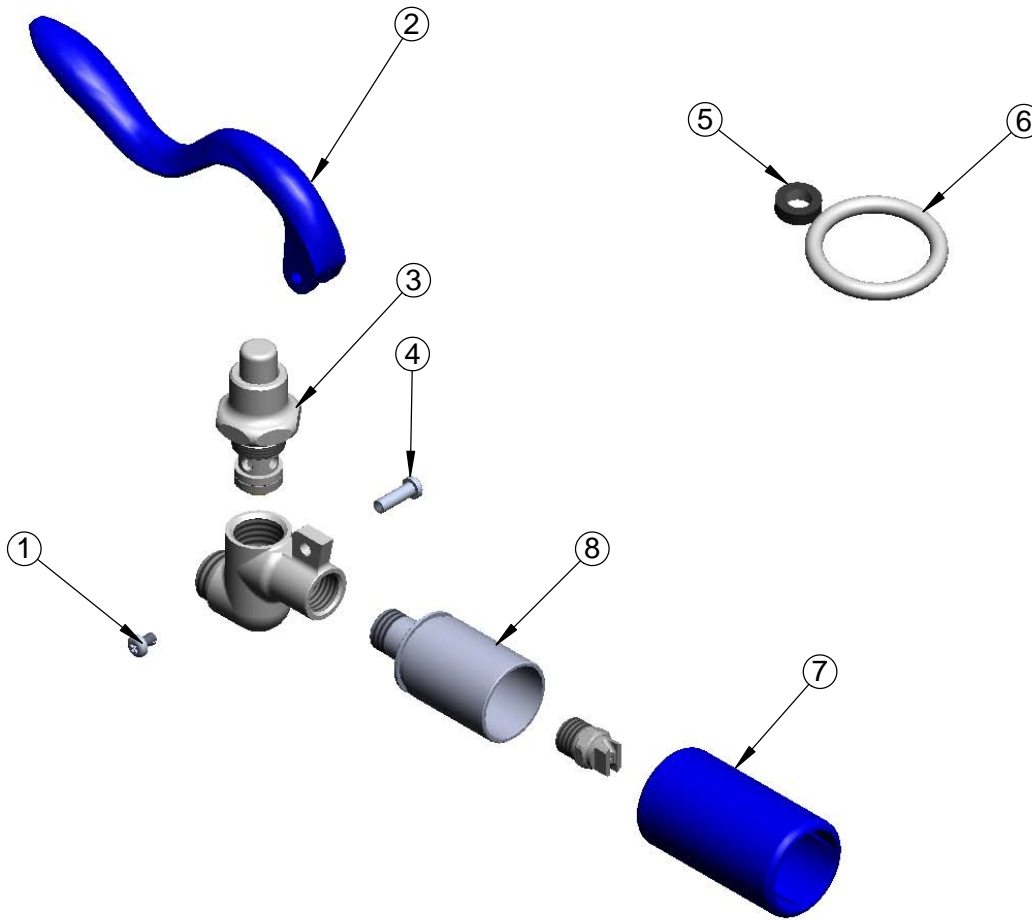

Product Specifications:
 Blue Self-Closing Pre-Rinse Spray Valve w/ 0.65 GPM Spray Nozzle

Product Compliance:
 ASME A112.18.1 / CSA B125.1
 NSF 61 - Section 9
 NSF 372 (Low Lead Content)
 EPA Act 2005 (PRSV)
 EPA WaterSense (PRSV)



T&S BRASS AND BRONZE WORKS, INC.
 2 Saddleback Cove / P.O. Box 1088
 Travelers Rest, SC 29690

Model No.
EB-0107-C35

Item No.

Travelers Rest, SC: 800-476-4103 • Simi Valley, CA: 800-423-0150 • Fax: 864-834-3518 • www.tsbrass.com

This Space for Architect/Engineer Approval

Job Name _____ Date _____

Model Specified _____ Quantity _____

Customer/Wholesaler _____

Contractor _____

Architect/Engineer _____

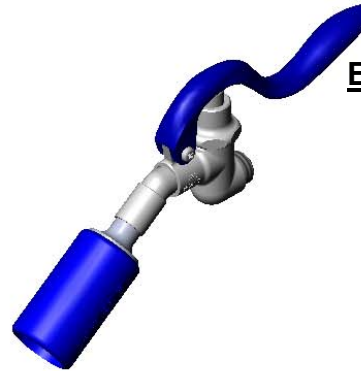

EPAct 2005 Compliant

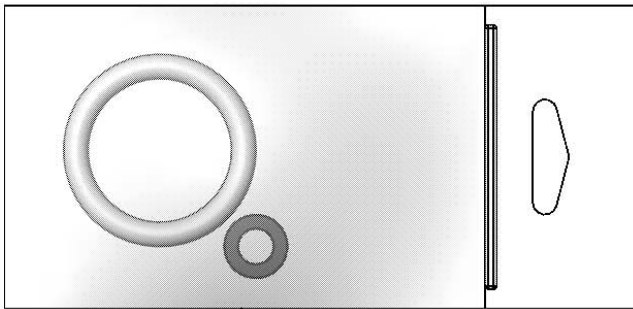

Furnished w/ Hose Washer & Hold Down Ring

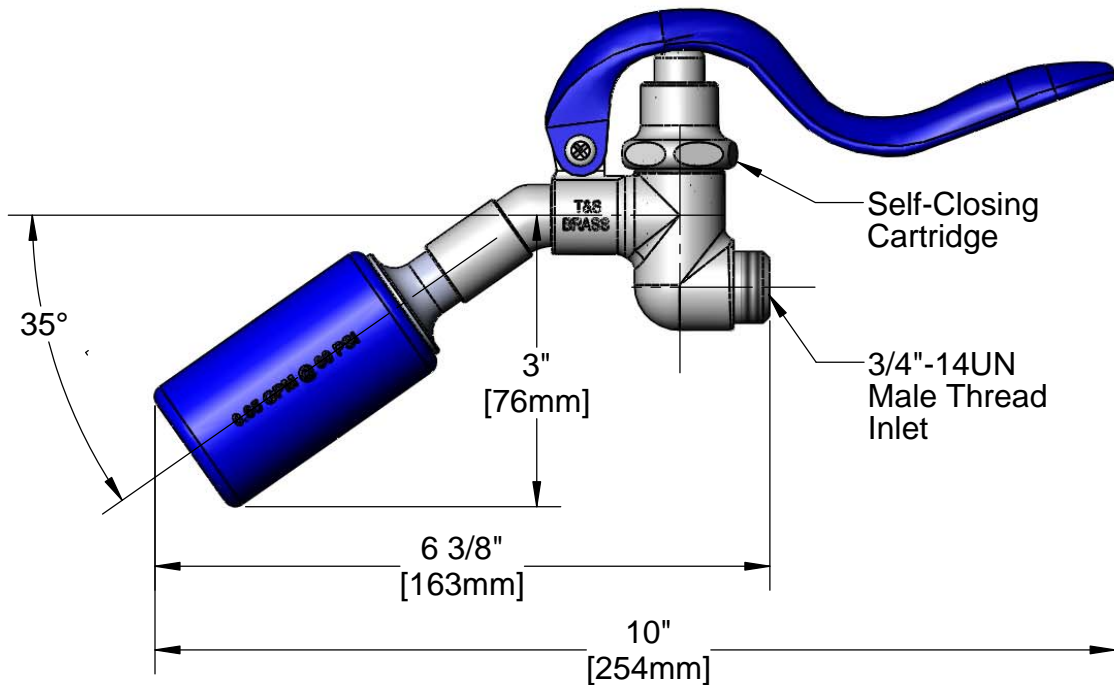

Product Specifications:
 Self-Closing Blue Pre-Rinse Spray Valve
 w/ 0.65 GPM Angled Spray Nozzle

Drawn
JRM

Checked
KJG

Approved
JHB

Scale:
1:2

Date:
06/26/12



T&S BRASS AND BRONZE WORKS, INC.
 2 Saddleback Cove / P.O. Box 1088
 Travelers Rest, SC 29690

Model No.
EB-0107-C35

Item No.

Travelers Rest, SC: 800-476-4103 • Simi Valley, CA: 800-423-0150 • Fax: 864-834-3518 • www.tsbrass.com

ITEM NO.	SALES NO.	DESCRIPTION
1	003199-45	Handle Screw, Spray Valve
2	011454-45	Handle, Blue Spray Valve
3	010594-40	B-107 Bonnet
4	003198-45	Handle Nut, Spray Valve
5	010476-45	#27 Washer
6	000907-45	Hold Down Ring
7	011499-45	Shield, Low Flow 0.65 GPM

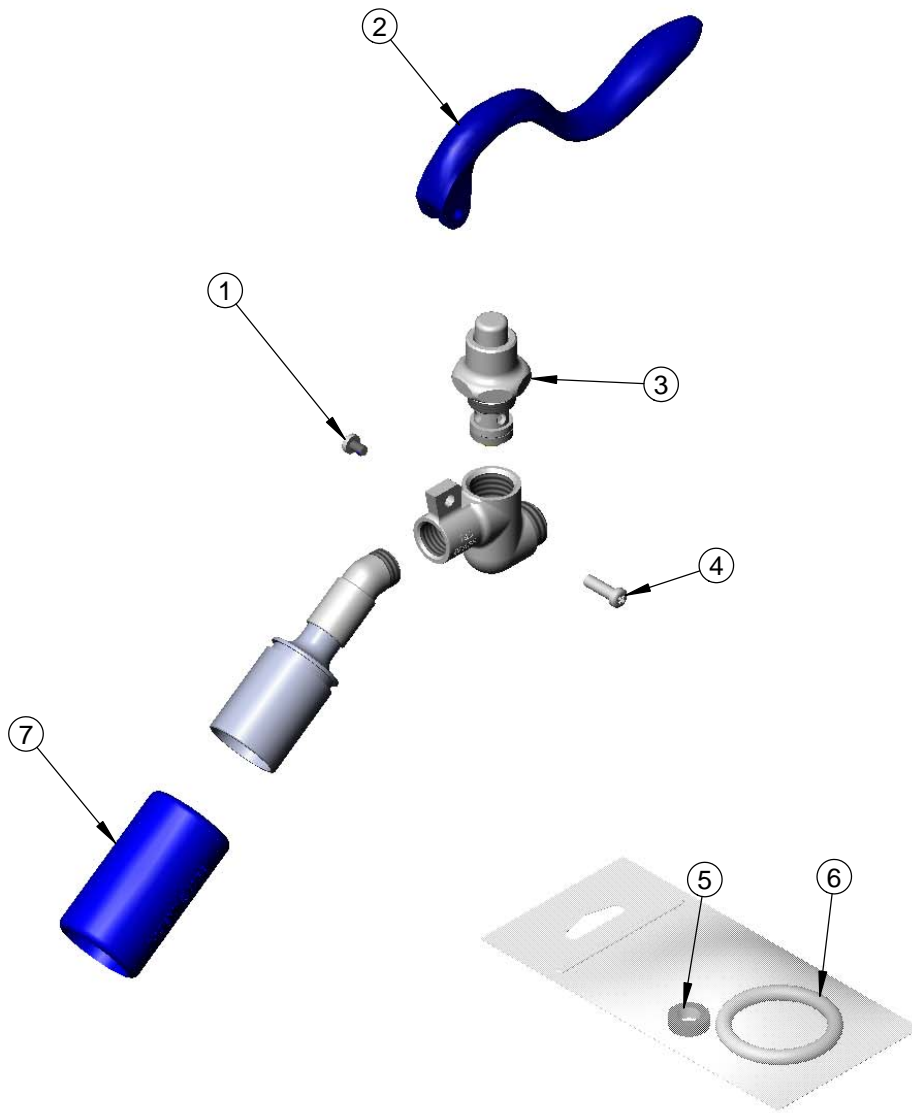

Product Specifications:
 Self-Closing Blue Pre-Rinse Spray Valve
 w/ 0.65 GPM Angled Spray Nozzle

Drawn JRM	Checked KJG	Approved JHB
Scale: NTS		Date: 06/26/12