

For Non-Health Hazard Fire Applications

Job Name _____

Contractor _____

Job Location _____

Approval _____

Engineer _____

Contractor's P.O. No. _____

Approval _____

Representative _____

Series 007DCDA

Double Check Detector Assemblies

Sizes: 2" – 3" (50 – 80mm)

Series 007DCDA Double Check Detector Assemblies are designed exclusively for use in accordance with water utility authority on non-health hazard containment requirements. It is mandatory to prevent the reverse flow of fire protection system substances, i.e., glycerin wetting agents, stagnant water and water of non-potable quality from being pumped or siphoned into the potable water line.

Benefits: Detects leaks...with emphasis on the cost of unaccountable water; incorporates a meter which allows the water utility to:

- detect underground leaks that historically create great annual cost due to waste.
- provide a detection point for unauthorized use. It can help locate illegal taps.

Modular check design concept facilitates maintenance and assembly access. All sizes are standardly equipped with resilient seated OSY shutoff valves and $\frac{5}{8}$ " x $\frac{3}{4}$ " (16 x 19mm) meter.

Features

- Fused epoxy coated cast iron unibody 2 $\frac{1}{2}$ " – 3" (65 – 80mm)
- Replaceable bronze seats
- Maximum flow at low pressure drop
- Compact for ease of installation
- Design simplicity for easy maintenance
- No special tools required for servicing
- Bronze body ball valve test cocks
- Modular spring loaded checks
- Furnished with bronze $\frac{5}{8}$ " x $\frac{3}{4}$ " (16 x 19mm) meter

Specifications

A Double Check Detector Assembly shall be installed on fire protection systems when connected to a potable water supply. Degree of hazard present is determined by the local authority having jurisdiction. The backflow preventer shall be a complete assembly including UL listed resilient seated OSY shutoff valves and four test cocks. The test cocks located on the backflow preventer shall be mounted at the top of the valve to reduce clearance problems and to assist in the evacuation of air from the assembly. The assembly shall consist of two independently operating modular poppet-type check valves. The check valves shall utilize captured springs and shall have replaceable seats. The checks shall be double-guided, both along the outside edge of the check module and through the center stem assembly. The seats shall be replaceable without the use of special tools. Seat retention shall be done by the use of an interlocking bayonet-style cage and the use of threaded seats or seat screws is prohibited. Access to the internal check assemblies shall be via a single top entry cover. The cover shall be securely held in place by stainless steel bolts. Where applicable the unit shall be FM approved with FM approved OSY resilient seated shutoff valves. The assembly shall include an auxiliary bypass line consisting of an approved backflow preventer and water meter.

The assembly shall be listed or approved under the requirements of ASSE Std. 1048, AWWA Std. C510-92 and CSA B64.5. Approved by the Foundation for Cross-Connection Control and Hydraulic Research at the University of Southern California. The assembly shall be a Watts Regulator Company Series 007DCDA.

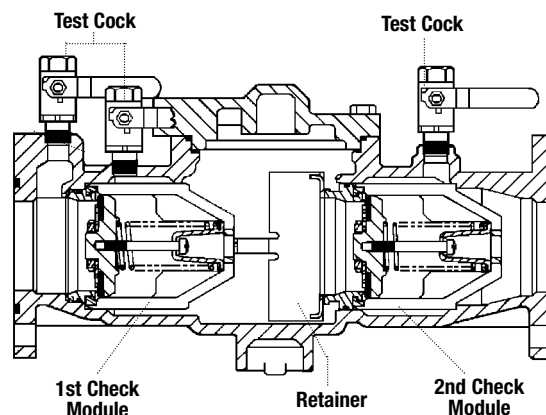
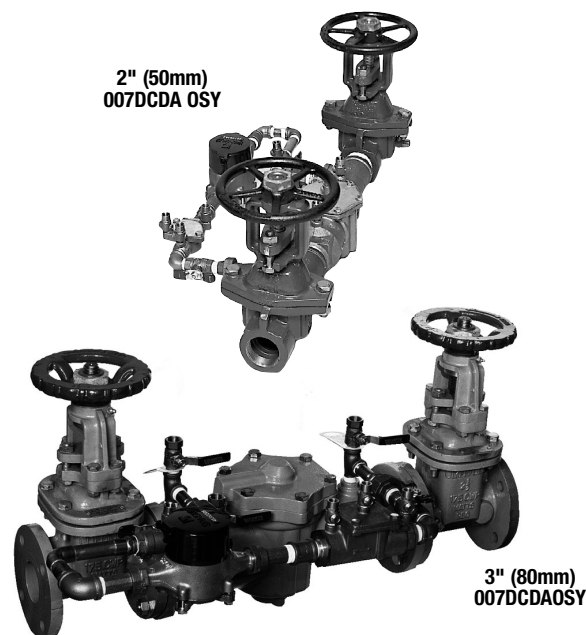

Now Available
WattsBox Insulated Enclosures.
 For more information, send for literature ES-WB.

**IMPORTANT: INQUIRE WITH GOVERNING AUTHORITIES
 FOR LOCAL INSTALLATION REQUIREMENTS**

WATTS®

Watts product specifications in U.S. customary units and metric are approximate and are provided for reference only. For precise measurements, please contact Watts Technical Service. Watts reserves the right to change or modify product design, construction, specifications, or materials without prior notice and without incurring any obligation to make such changes and modifications on Watts products previously or subsequently sold.

Capacity

*Typical maximum system flow rate (7.5 feet/sec.). **UL rated flow

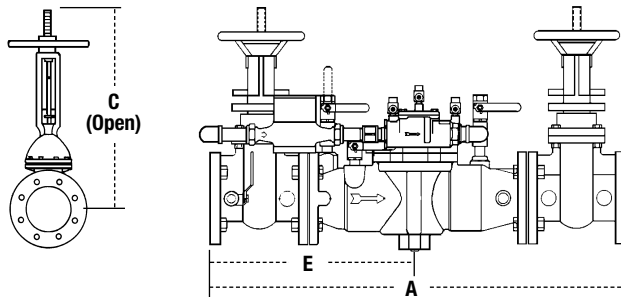
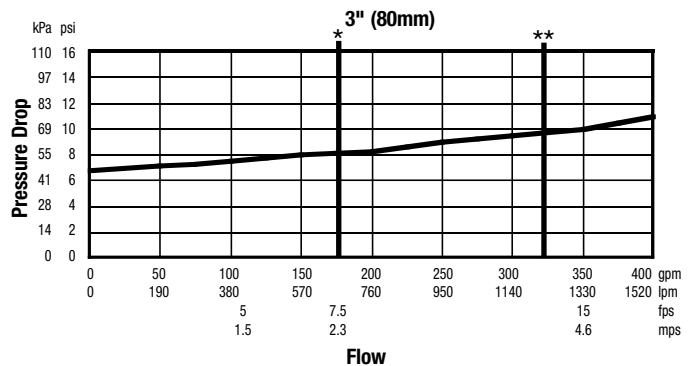
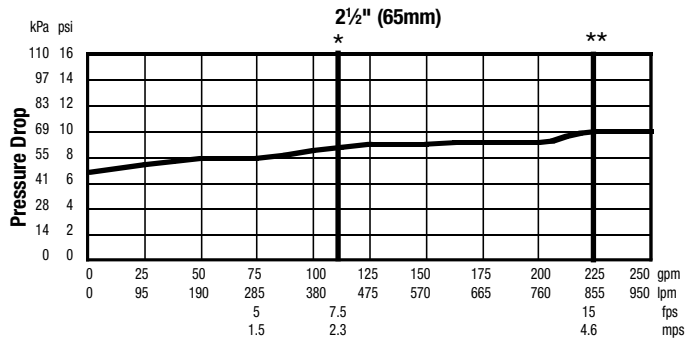
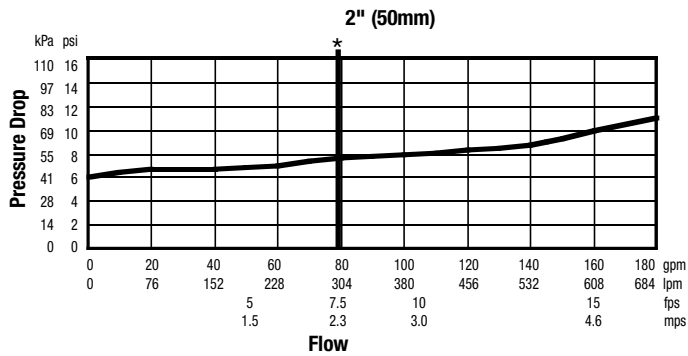

Available

Suffix:
CFM – cubic feet per minute meter
GPM – gallons per minute meter

Materials

Body: 2 1/2" & 3" (65 – 80mm) epoxy coated cast iron
2" (50mm) bronze
Seats: Bronze
Discs: Silicone
Springs: Stainless steel
Meter: Bronze 3/8" x 3/4" (16 x 19mm)

Pressure – Temperature

Temperature Range: 33°F – 110°F (0.5°C – 43°C) continuous,
140°F (60°C) intermittent.
Maximum Working Pressure: 175psi (12.1 bar)

Standards

AWWA Standard C510-92
CSA B64.5
IAPMO PS 31

Approvals



*Approved by the Foundation for Cross-Connection Control and Hydraulic Research at the University of Southern California.

Note: *2" – 2 1/2" (50 – 65mm) 007DCDA horizontal or vertical upward flow position

*3" (80mm) 007DCDA horizontal only

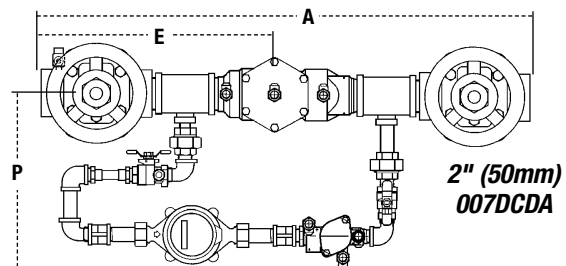
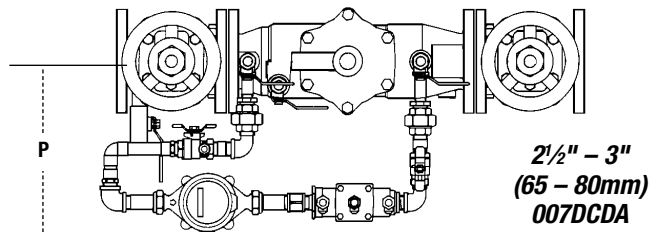

SIZE (DN)		DIMENSIONS				WEIGHT					
in.	mm	A		C		E		P		lbs.	kgs.
		in.	mm	in.	mm	in.	mm	in.	mm		
2	50	35 1/8	892	13 1/2	343	16 3/4	426	12 1/4	311	97	44
2 1/2	65	33 1/4	845	16 3/8	416	16 3/8	416	12 5/16	313	164	74
3	80	34 1/4	870	18 7/8	479	16 5/8	422	12 5/16	313	196	89



Backflow Prevention Products

ES-007DCDA 0646



USA: 815 Chestnut St., No. Andover, MA 01845-6098; www.watts.com
Canada: 5435 North Service Rd., Burlington, ONT. L7L 5H7; www.wattscanada.ca

© Watts Regulator Company, 2006