



T&S BRASS AND BRONZE WORKS, INC.

2 Saddleback Cove / P.O. Box 1088
Travelers Rest, SC 29690

Model No.

B-1027

Item No.

Travelers Rest, SC: 800-476-4103 • Simi Valley, CA: 800-423-0150 • Fax: 864-834-3518 • www.tsbrass.com

This Space for Architect/Engineer Approval

Job Name _____ Date _____

Model Specified _____ Quantity _____

Customer/Wholesaler _____

Contractor _____

Architect/Engineer _____

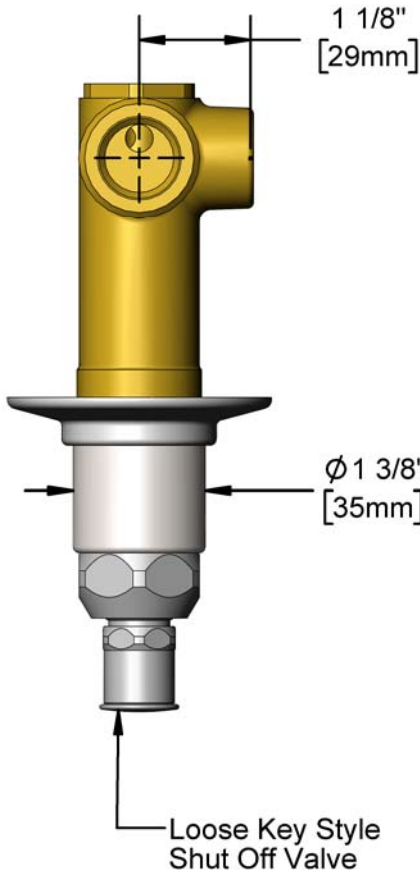

Loose Key Tee Handle
(Operates Loose Key
Stop) Mounting Screw
Included

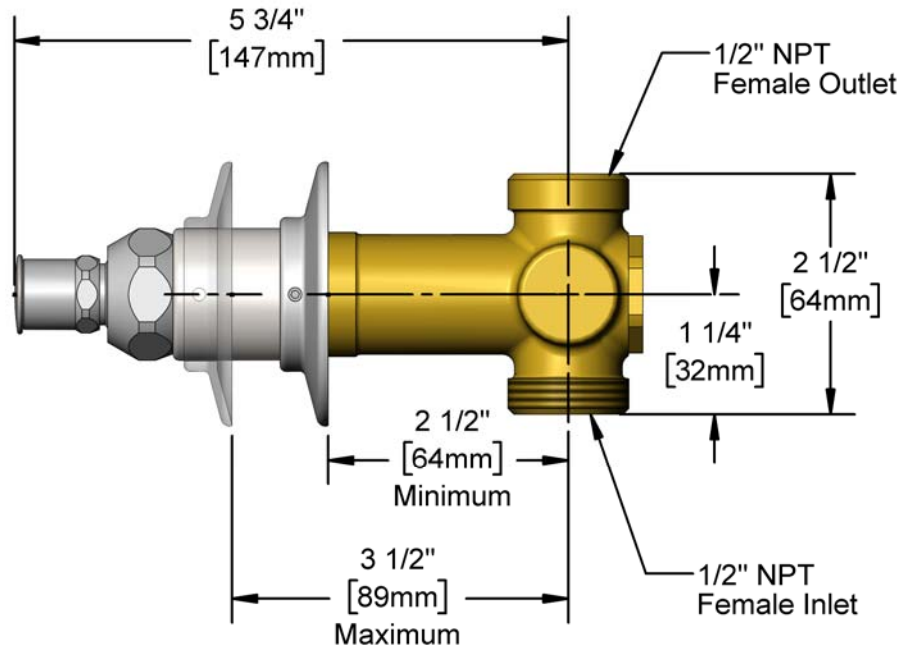

Product Specifications:

Concealed Straight Loose Key Valve, 1/2" NPT Female Outlet & 1/2" NPT Female Inlet

Product Compliance:

ASME A112.18.1 / CSA B125.1
NSF 61 - Section 9
NSF 372 (Low Lead Content)



T&S BRASS AND BRONZE WORKS, INC.

2 Saddleback Cove / P.O. Box 1088
Travelers Rest, SC 29690

Model No.

B-1027

Item No.

Travelers Rest, SC: 800-476-4103 • Simi Valley, CA: 800-423-0150 • Fax: 864-834-3518 • www.tsbrass.com

ITEM NO.	SALES NO.	DESCRIPTION
1	002432-45	Screw, Tee Handle
2	001802-45	Handle, Supply Stop "T"
3	001605-45	Cap
4	124A-NS	Loose Key Style Shut Off Valve w/ Tee Handle & Cap
5	001501-40	Escutcheon
6	000939-45	Escutcheon, Set Screw
7	151F	Escutcheon Tube
8	001062-45	O-Ring
9	001702-45	O-Ring

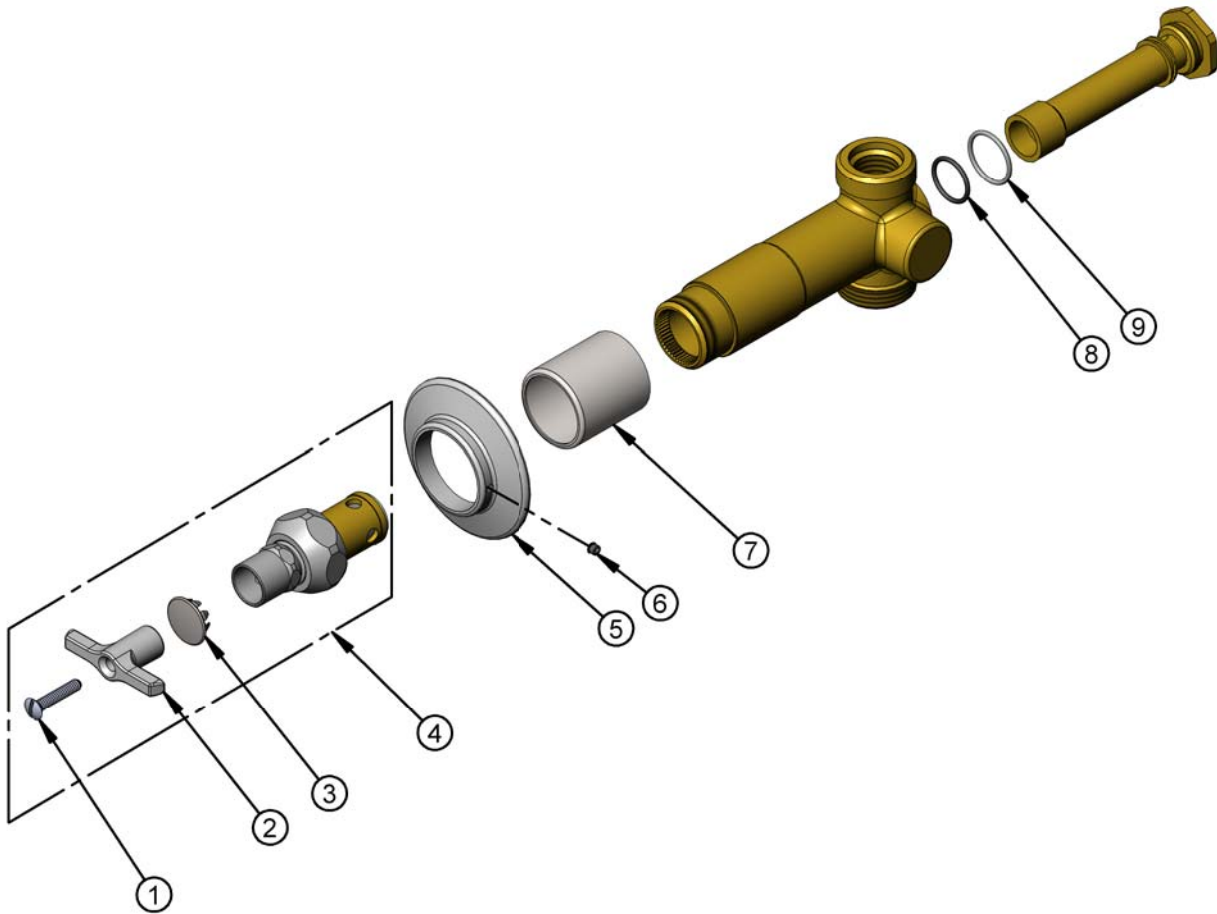

Product Specifications:

Concealed Straight Loose Key Valve, 1/2" NPT Female Outlet & 1/2" NPT Female Inlet

Product Compliance:

ASME A112.18.1 / CSA B125.1
NSF 61 - Section 9
NSF 372 (Low Lead Content)